

MATH4321 — Game Theory

Topic Three: Games with a continuum of strategies

3.1 Nash equilibrium under a continuum of strategies

- Calculus approach of finding a Nash equilibrium
- Electoral competition
- Buy-it-now price of an item
- Tragedy of the commons

3.2 Economic applications

- Cournot model
- Stackelberg model

3.3 Auctions

- Open-bid and closed-bid; first-price versus second-price
- Linear bidding rules of the Dutch auction
- Truthful bids in an English auction
- Revenue equivalence theorem

3.4 Duel games

- Nature of the duel games
- Discrete steps: Dominance and backward induction
- Continuous models: noisy duel and silent duel

3.1 Nash equilibrium under a continuum of strategies

- N players in the game
- Each player's payoff depends on his choice of strategy and the choices of the other players. The payoffs are real-valued functions defined on a multivariate domain

$$u_i : Q_1 \times Q_2 \times \dots \times Q_N \rightarrow \mathbb{R}, \quad i = 1, 2, \dots, N.$$

We assume a continuum of strategies.

Definition of a Nash equilibrium point

A strategy profile $q^* = (q_1^* \ q_2^* \ \dots \ q_N^*) \in Q_1 \times Q_2 \times \dots \times Q_N$ is a Nash equilibrium for the game with payoff functions $\{u_i(q_1, q_2, \dots, q_N)\}$, $i = 1, 2, \dots, N$, if for each player, $i = 1, 2, \dots, N$, we have

$$u_i(q_i^*, q_{-i}^*) \geq u_i(q_i, q_{-i}^*) \text{ for all } q_i \in Q_i.$$

For each player, he cannot be better off if he deviates unilaterally from his only part of the Nash equilibrium strategy while the other players play their Nash equilibrium strategies.

Sufficient conditions for Nash equilibriums

We assume the strategy sets Q_i to be open intervals and the payoff functions to have at least two continuous derivatives (necessary for the second derivative test). If $(q_1^*, q_2^*, \dots, q_N^*)$ satisfies the 3 conditions below, then it is sufficient to be a Nash equilibrium.

1. Satisfy the simultaneous system of equations

$$\frac{\partial u_i}{\partial q_i}(q_1, q_2, \dots, q_N) = 0, \quad i = 1, 2, \dots, N.$$

Each equation $\frac{\partial u_i}{\partial q_i} = 0, i = 1, 2, \dots, N$, gives the first order condition of finding $\arg \max_{t \in Q_i} u_i(q_1, \dots, q_{i-1}, t, q_{i+1}, \dots, q_N)$, a best response of player i to q_{-i} . The solution of the simultaneous system of these N equations corresponds to finding the intersection of the best response functions. Recall that a Nash equilibrium consists of each player's best response to the parts of the Nash equilibrium played by others.

2. q_i^* is the only stationary point of the function

$$q \mapsto u_i(q_1^*, \dots, q_{i-1}^*, q, q_{i+1}^*, \dots, q_N^*) \text{ for } q \in Q_i.$$

3. Satisfy the second order condition for a maximum

$$\frac{\partial^2 u_i}{\partial q_i^2}(q_1, q_2, \dots, q_N) < 0, \quad i = 1, 2, \dots, N,$$

evaluated at $q_1^*, q_2^*, \dots, q_N^*$.

The last two conditions guarantee that q_i^* is the unique maximum value of $u_i(q_i, q_{-i}^*)$.

We take the partial of u_i with respect to q_i , not the partial of each payoff function with respect to all variables. We are not trying to maximize each payoff function over all the variables, but each payoff function as a function the player controls, namely, q_i for player i .

Example

Consider a two-person game with strategy sets $Q_1 = Q_2 = \mathbb{R}$. The payoff functions are

$$u_1(q_1, q_2) = -q_1q_2 - q_1^2 + q_1 + q_2 \text{ and } u_2(q_1, q_2) = -3q_2^2 - 3q_1 + 7q_2.$$

The first order derivatives are

$$\frac{\partial u_1}{\partial q_1} = -q_2 - 2q_1 + 1 \text{ and } \frac{\partial u_2}{\partial q_2} = -6q_2 + 7.$$

There is only one stationary point that satisfies

$$\frac{\partial u_1}{\partial q_1} = 0 \text{ and } \frac{\partial u_2}{\partial q_2} = 0$$

simultaneously. The solution is $(q_1 \ q_2) = (-\frac{1}{12} \ \frac{7}{6})$.

Lastly, we check: $\frac{\partial^2 u_1}{\partial q_1^2} \Big|_{(-\frac{1}{12} \ \frac{7}{6})} = -2 < 0$ and $\frac{\partial^2 u_2}{\partial q_2^2} \Big|_{(-\frac{1}{12} \ \frac{7}{6})} = -6 < 0$. Therefore, $(q_1 \ q_2) = (-\frac{1}{12} \ \frac{7}{6})$ is the unique Nash equilibrium.

Best response functions

We use the intersection of best response strategies to find a Nash equilibrium. Given q_{-k} , the best response of player k satisfies

$$u_k(q_k, q_{-k}) = \max_{t \in Q_k} u_k(t, q_{-k}) \Leftrightarrow q_k = \arg \max_{t \in Q_k} u_k(t, q_{-k}).$$

That is, q_k provides the maximum payoff for player k , given the values of the other players' q_{-k} .

Let $u_1(x, y) = x(2 + 2y - x)$ and $u_2(x, y) = y(4 - x - y)$, $x, y \geq 0$. Note that

$$\frac{\partial u_1}{\partial x} = 2 + 2y - 2x \quad \text{and} \quad \frac{\partial u_2}{\partial y} = 4 - x - 2y.$$

The best response functions for the players are

$$B_1(y) = x(y) \text{ that satisfies } u_1(x(y), y) = \max_x u_1(x, y),$$
$$B_2(x) = y(x) \text{ that satisfies } u_2(x, y(x)) = \max_y u_2(x, y).$$

Player I plays $B_1(y) = x(y)$ when Player II plays y ; player II plays $B_2(x) = y(x)$ when player I plays x .

For a given value of y , we solve for x such that $\frac{\partial u_1}{\partial x} = 0$; and similarly, for a given value of x , we solve for y such that $\frac{\partial u_2}{\partial x} = 0$.

We consider

$$\begin{aligned}\frac{\partial u_1}{\partial x} = 0 &\Rightarrow x(y) = 1 + y; \\ \frac{\partial u_2}{\partial y} = 0 &\Rightarrow y(x) = \frac{4 - x}{2}, \text{ requiring } 4 \geq x \geq 0.\end{aligned}$$

The Nash equilibrium is where the pair of best response curves cross. Solving $x(y) = y(x)$, we obtain $x^* = 2$ and $y^* = 1$.

Taking the second partial derivatives, we obtain $\frac{\partial^2 u_1}{\partial x^2} \Big|_{(2,1)} = -2$ and

$\frac{\partial^2 u_2}{\partial y^2} \Big|_{(2,1)} = -2$. They show that they are indeed maxima of the respective payoff functions. Also, their payoff values at the Nash equilibrium are

$$u_1(2, 1) = 4 \text{ and } u_2(2, 1) = 1.$$

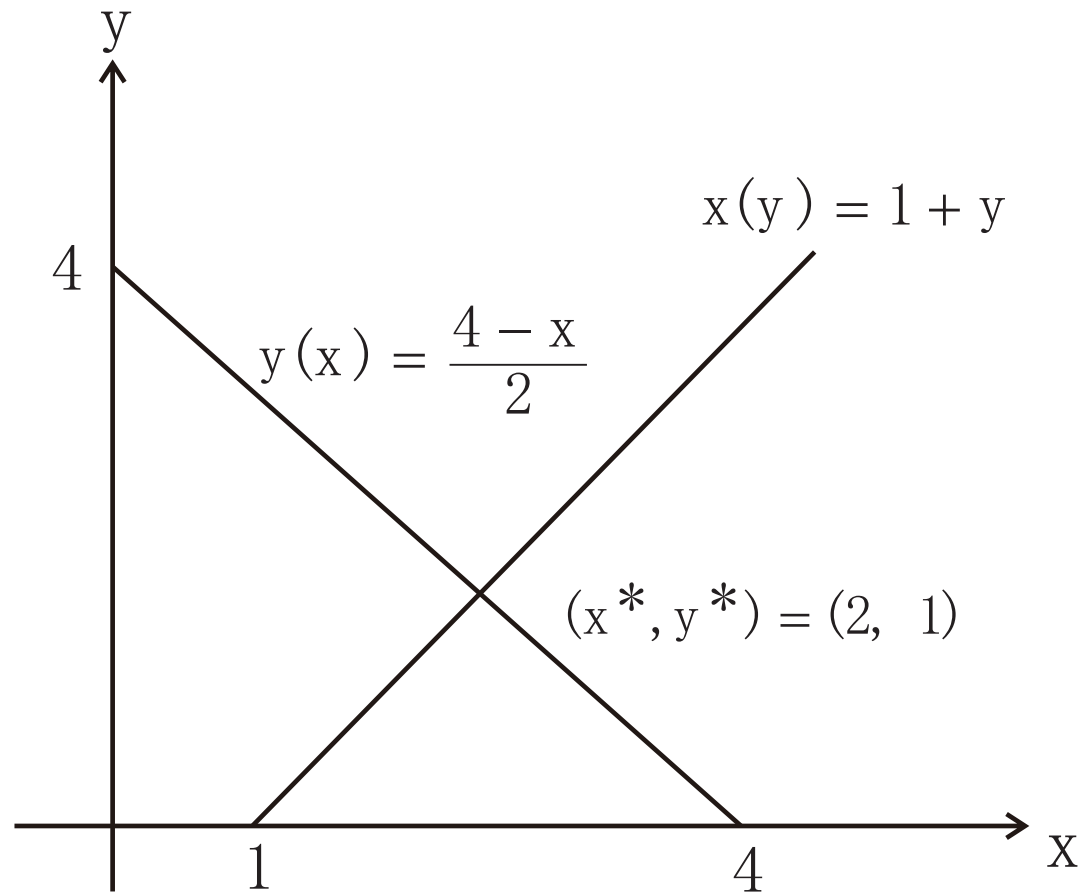

Intersection of the two best response function curves gives the Nash equilibrium. Suppose Player 2 plays his part of Nash equilibrium $y^* = 1$, then Player 1 cannot be better off by deviating from playing his part of Nash equilibrium $x^* = 2$ since the maximum of $u_1(x, 1) = x(4 - x)$ is achieved at $x = 2$.

Higher payoff achieved if the opponent's strategy is known

Knowing that Player 2 always uses his best response function, we would like to show that Player 1 can do better. This resembles the leader-follower game, where Player 2 (follower) always uses the best response function when the leader (Player 1) announces his choice of x .

Suppose that Player 1 (leader) assumes that Player 2 (follower) will always use the best response function: $y(x) = \frac{4-x}{2}$. If this is so, then Player 1 would take advantage to choose x to maximize

$$u_1(x, y(x)) = x \left[2 + 2 \left(\frac{4-x}{2} \right) - x \right] = 6x - 2x^2.$$

This function has a maximum at $x = \frac{3}{2}$ and

$$u_1\left(\frac{3}{2}, y\left(\frac{3}{2}\right)\right) = \frac{9}{2} > 4.$$

Subsequently, since $y\left(\frac{3}{2}\right) = \frac{5}{4}$ and $u_2\left(\frac{3}{2}, \frac{5}{4}\right) = \frac{25}{16} > 1$, both players do better if they play in this manner.

On the other hand, if Player 2 maximizes

$$u_2(x(y), y) = y(4 - 1 - y - y) = y(3 - 2y),$$

then $y = \frac{3}{4}$ and $x(\frac{3}{4}) = \frac{7}{4}$. We have $u_1(\frac{7}{4}, \frac{3}{4}) = \frac{49}{16} < 4$ and $u_2(\frac{7}{4}, \frac{3}{4}) = \frac{9}{8} > 1$. Only Player 2 does better in this example.

Remarks

- When the leader (player 2) stays with $y = \frac{3}{4}$, the follower (player 1) has to stay with $x(y) = 1 + y = \frac{7}{4}$ as the best response.
- However, when the follower (player 1) stays with $x = \frac{7}{4}$, the best response of the leader (player 2) is $y(x) = \frac{4-x}{2} = \frac{4-\frac{7}{4}}{2} = \frac{9}{8} \neq \frac{3}{4}$. Note that $u_2(\frac{7}{4}, \frac{9}{8}) = \frac{9}{8}(4 - \frac{7}{4} - \frac{9}{8}) = \frac{9}{8}(\frac{9}{8}) > \frac{9}{8}$. This is because in the above maximization of $u_2(x(y), y)$, it is restricted to the choice of x to be $x(y) = 1 + y$. Note that the best response played by the leader (player 2) at $x = \frac{7}{4}$ has no such restriction.

Nash equilibrium and maximization of payoff functions

Suppose that we have a two-person game with payoff functions $u_i(q_1, q_2)$, $i = 1, 2$. Suppose there is a strategy pair (q_1^*, q_2^*) that maximize both u_1 and u_2 as functions of the pair (q_1, q_2) (though it is unlikely to occur at the same pair). We then have

$$u_1(q_1^*, q_2^*) = \max_{(q_1, q_2)} u_1(q_1, q_2) \text{ and } u_2(q_1^*, q_2^*) = \max_{(q_1, q_2)} u_2(q_1, q_2).$$

Therefore,

$$u_1(q_1^*, q_2^*) \geq u_1(q_1, q_2^*) \text{ and } u_2(q_1^*, q_2^*) \geq u_2(q_1^*, q_2)$$

for every $q_1 \neq q_1^*$ and $q_2 \neq q_2^*$. Hence, (q_1^*, q_2^*) automatically satisfies the definition of a Nash equilibrium.

Actually, a maximum of both payoffs is a much stronger requirement than a Nash equilibrium. This is in a similar spirit with the earlier result on discrete strategies: A strategy profile that is weakly Pareto-dominating all other strategy profiles is a Nash equilibrium.

Example

Consider $u_1(q_1, q_2) = q_2^2 - q_1^2$ and $u_2(q_1, q_2) = q_1^2 - q_2^2$, $-1 \leq q_1 \leq 1$ and $-1 \leq q_2 \leq 1$.

There is a unique Nash equilibrium at $(q_1^*, q_2^*) = (0, 0)$ since

$$\frac{\partial u_1(q_1, q_2)}{\partial q_1} = -2q_1 = 0 \text{ and } \frac{\partial u_2(q_1, q_2)}{\partial q_2} = -2q_2 = 0$$

gives $q_1^* = q_2^* = 0$. However, we observe

$$u_1(q_1^*, q_2^*) = 0, \max_{(q_1, q_2)} u_1(q_1, q_2) = 1 \text{ and } u_2(q_1^*, q_2^*) = 0, \max_{(q_1, q_2)} u_2(q_1, q_2) = 1.$$

This shows that $(q_1^*, q_2^*) = (0, 0)$ maximizes neither of the payoff functions.

Indeed, there does not exist a point that maximizes both u_1 and u_2 at the same point (q_1, q_2) . Actually, it is almost unlikely to have existence of such a point since u_1 and u_2 are different payoff functions.

Electoral competition

Each of several candidates chooses a policy; each citizen has preferences over policies and votes for one of the candidates.

Form of strategic game

A simple version of this model is a strategic game in which the players are the candidates and a policy is a number, referred to as a “position”. Policy takes values in \mathbb{R}^+ , the set of positive real number. The compression of all policy differences into one dimension is a major abstraction, though political positions are often categorized on a left-right axis.

After the candidates have chosen positions, each of a set of citizens votes (nonstrategically) for the candidate whose position she likes best. The candidate who obtains the most votes wins.

Each candidate cares only about winning; no candidate has an ideological attachment to any position. There is a continuum of voters, each with a favorite position. The distribution of these favorite positions over the set of all possible positions is arbitrary. In particular, this distribution may not be uniform: a large fraction of the voters may have favorite positions close to one point, while few voters have favorite positions close to some other point.

Let x_i be the position as the policy stand of candidate i . We assume $x_1 \geq 0$ and $x_2 \geq 0$, and define the payoff functions of the candidates to be

$$u_i(x_1, x_2) = \begin{cases} 1 & \text{if Player } i \text{ wins} \\ 0 & \text{if tie} \\ -1 & \text{if Player } i \text{ loses} \end{cases}, \quad i = 1, 2.$$

In mathematical sense, if the candidates' policies and voters' positions are continuum, then the chance of tie for the first place is probabilistically zero.

Median favorite position

A position that turns out to have special significance is the *median* favorite position: the position m with the property that exactly half of the voters' favorite positions are at most m , and half of the voters' favorite positions are at least m .

Each voter's distaste for any position is given by the distance between that position and her favorite position. Under this assumption, each candidate attracts the votes of all citizens whose favorite positions are closer to her position than to the position of any other candidate.

Two-person game

We find a Nash equilibrium of the game by studying the players' best response functions. Fix the position x_2 of candidate 2 and consider the best position for candidate 1.

(i) $x_2 < m$

If candidate 1 takes a position to the left of x_2 then candidate 2 attracts the votes of all citizens whose favorite positions are to the right of $\frac{1}{2}(x_1 + x_2)$, a set that includes the 50% of citizens whose favorite positions are to the right of m , and more. Thus candidate 2 wins, and candidate 1 loses.

If candidate 1 takes a position to the right of x_2 then she wins so long as the dividing line between her supporters and those of candidate 2 is less than m .

If she is so far to the right such that this dividing line lies to the right of m then she loses.

Her set of best responses to x_2 is the set of positions that satisfies the condition $\frac{1}{2}(x_1 + x_2) < m$, or equivalently, $x_1 < 2m - x_2$. The candidate 1's set of best responses to x_2 is the set of all positions between x_2 and $2m - x_2$ (excluding the points x_2 and $2m - x_2$ since these positions lead to a tie).

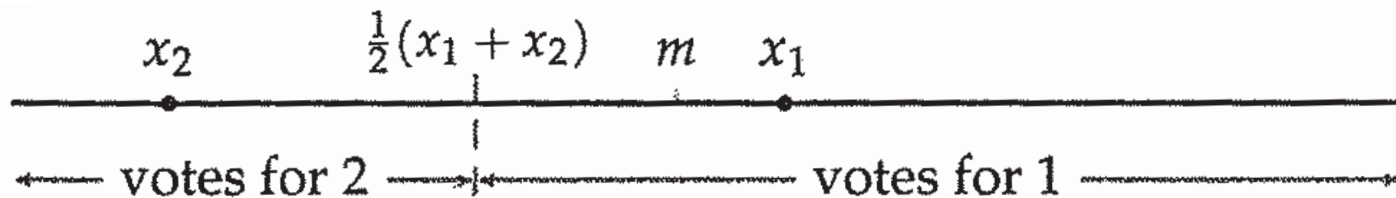

An action profile (x_1, x_2) for which candidate 1 wins.

(ii) $x_2 > m$

By symmetry, candidate 1's set of best responses to x_2 is the set of all positions between $2m - x_2$ and x_2 .

Finally consider the case in which $x_2 = m$. In this case candidate 1's unique best response is to choose the *same* position, m ! If she chooses any other position then she loses, whereas if she chooses m then she ties for first place.

In summary, candidate 1's best response function is defined by

$$B_1(x_2) = \begin{cases} \{x_1 : x_2 < x_1 < 2m - x_2\} & \text{if } 0 \leq x_2 < m \\ \{m\} & \text{if } x_2 = m \\ \{x_1 : 2m - x_2 < x_1 < x_2\} & \text{if } m < x_2 \leq 2m \\ \{x_1 : x_1 < x_2\} & \text{if } x_2 > 2m. \end{cases}$$

Since $u_1 = -u_2$, so the best response set of Player 1 is the complement to that of Player 2 in the x_1 - x_2 plane, where $x_1 > 0$ and $x_2 > 0$.

Plot of the candidates' best response functions

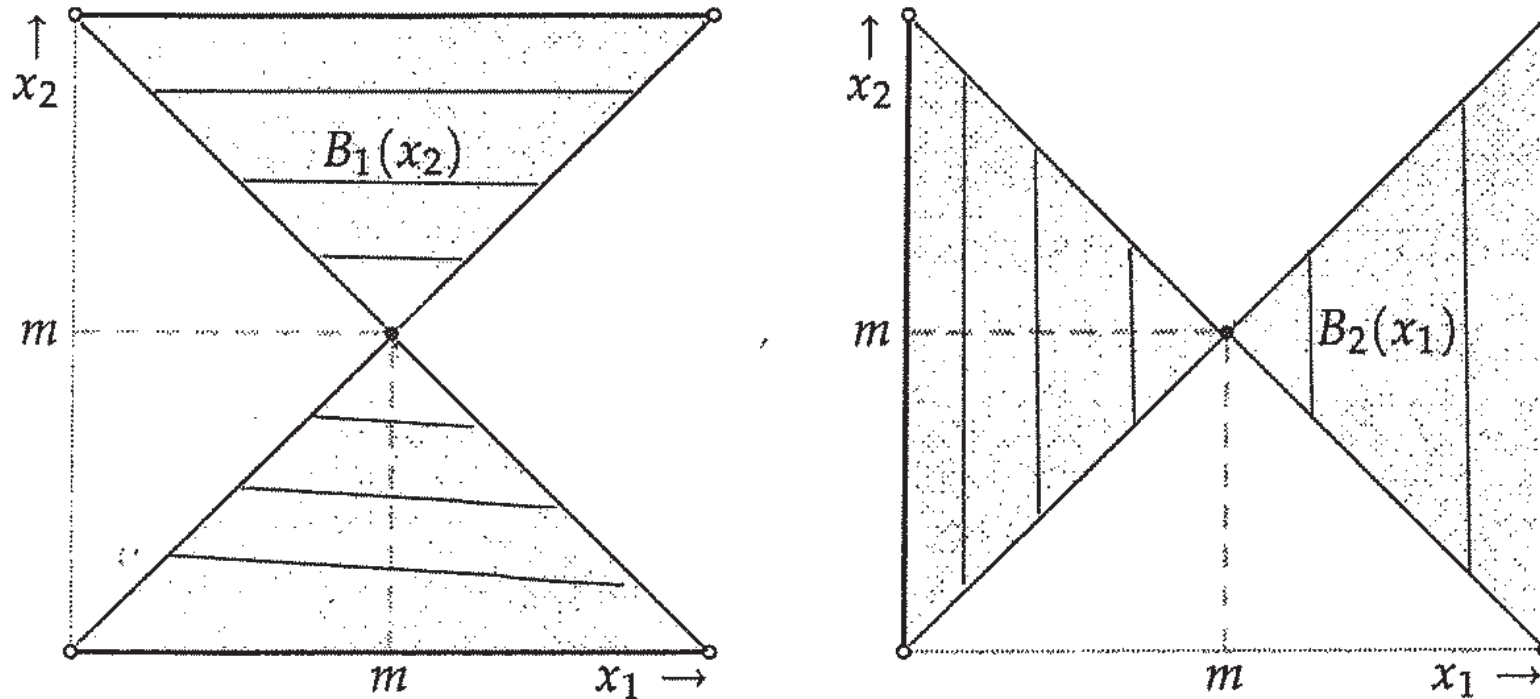

The candidates' best response functions in electoral competition with two candidates. Candidate 1's best response function is in the left panel; candidate 2's is in the right panel.

If you superimpose the two best response functions, the game has a unique Nash equilibrium, in which both candidates choose the position m , the voters' median favorite position. However, the outcome (m, m) leads to a tie in the election. It lies in the intersection of the best response sets of the two players.

The competition between the candidates to secure a majority of the votes drives them to select the same position, equal to the median of the citizens' favorite positions.

Remark

In Hong Kong district Legco election, there are multiple (more than 2) candidates per district. A candidate can win even she may capture 10-15% of the total votes. This may induce a candidate to choose a highly polarized policy stand (to the far left or far right).

Alternative argument to search for unique Nash equilibrium

We can make a direct argument that (m, m) is the unique Nash equilibrium of the game, without constructing the best response functions.

First, we establish that (m, m) is a Nash equilibrium: it results in a tie, and if either candidate chooses a position different from m then she loses.

To see this, suppose Player I plays $x_1 = m$, Player II plays $x_2 = m + \Delta$, $\Delta > 0$. Then Player I receives votes for $x < m + \frac{\Delta}{2}$ while Player II receives votes for $x > m + \frac{\Delta}{2}$. Player I receives 50% votes plus $\frac{\Delta}{2}$ more, so Player I wins. Same argument applies if $\Delta < 0$.

Second, we show that there is no other pair of positions is a Nash equilibrium, by the following argument. We prove by contradiction. Suppose a Nash equilibrium other than the profile (m, m) exists, it suffices to show that one player can be better off if he deviates from playing his part of the Nash equilibrium.

- If one candidate loses then she can do better by moving to m , where she either wins outright (if her opponent's position is different from m) or ties for first place (if her opponent's position is m).
- If the candidates tie (because their positions are either the same or symmetric about m), then either candidate can do better by moving to m , where she wins outright.

Buy-it-now price of an item

There are $N > 1$ buyers with valuations of a valuable item, V_i , $i = 1, 2, \dots, N$. We assume that V_i 's are random and the seller knows its joint cumulative distribution function

$$F(v_1, v_2, \dots, v_N) = P[V_1 \leq v_1, V_2 \leq v_2, \dots, V_N \leq v_N].$$

We consider the optimal decision made by the seller of setting the buy-it-now price p . This is not quite a game model. It serves as a motivation of the later auction game model, where we have one seller and a group of buyers.

A buyer with his personal valuation higher than or equal to p would buy the object. There may be several persons who are willing to offer p to buy the item. Some rule may be set to determine the final buyer, like first-come-first-serve. The gain to the seller is $p - r$, where r is the true non-negotiable lowest price. The seller's payoff function $U(p)$ is given by

$$U(p) = \begin{cases} p - r & \text{if } \max(V_1, V_2, \dots, V_N) \geq p \\ 0 & \text{if } \max(V_1, V_2, \dots, V_N) < p \end{cases}.$$

The probability that the object can be sold is given by

$$f(p) = 1 - P[V_1 < p, \dots, V_N < p] = 1 - F(p, \dots, p),$$

which is known to the seller. The seller's expected payoff is

$$u(p) = E[U(p)] = (p - r)f(p).$$

The seller wants to find p^* so as to maximize $u(p)$. We consider the first order condition:

$$(p^* - r)f'(p^*) + f(p^*) = 0,$$

and this gives a maximum as long as the second order condition is satisfied, where

$$(p^* - r)f''(p^*) + 2f'(p^*) \leq 0.$$

Suppose we assume $\{V_i\}$ to be a collection of N independent and identically distributed random variables, and let $G(v) = F_i(v)$, $i = 1, 2, \dots, N$. We have

$$f(p) = 1 - G(p)^N \text{ or } f'(p) = -NG(p)^{N-1}G'(p),$$

and we write $g(p) = G'(p)$.

The first order condition becomes

$$-(p^* - r)NG(p^*)^{N-1}g(p^*) + 1 - G(p^*)^N = 0.$$

Uniformly distributed valuation

We may assume the (random) valuations to be uniformly distributed over $[r, R]$ for analytical tractability in our subsequent analysis. In this case, we have

$$g(p) = \begin{cases} \frac{1}{R-r}, & r < p < R \\ 0 & \text{otherwise} \end{cases} \quad \text{and} \quad G(p) = \begin{cases} 0 & \text{if } p < r \\ \frac{p-r}{R-r} & \text{if } r \leq p \leq R \\ 1 & \text{if } p > R \end{cases}$$

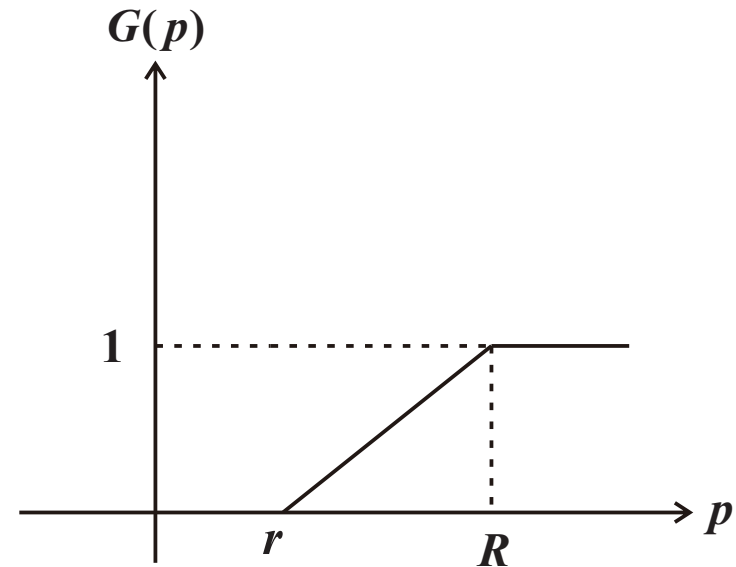
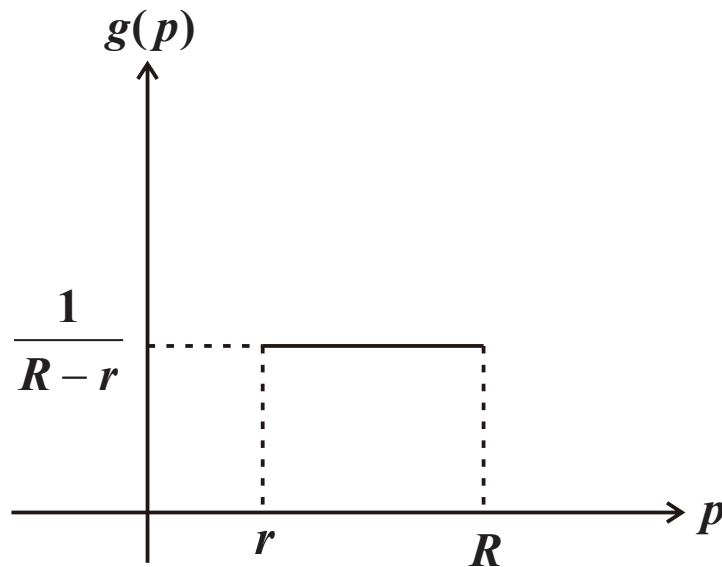

The first order condition becomes

$$-(p^* - r)N \left(\frac{p^* - r}{R - r}\right)^{N-1} \frac{1}{R - r} + 1 - \left(\frac{p^* - r}{R - r}\right)^N = 0,$$

so that

$$(N + 1) \left(\frac{p^* - r}{R - r}\right)^N = 1$$

giving

$$p^* = r + (R - r) \left(\frac{1}{N + 1}\right)^{\frac{1}{N}}.$$

Note that $f(p^*) = 1 - \left(\frac{p^* - r}{R - r}\right)^N = 1 - \frac{1}{N + 1} = \frac{N}{N + 1}$. The corresponding expected payoff is

$$u(p^*) = (p^* - r)f(p^*) = \frac{(R - r)N}{(N + 1)^{1 + \frac{1}{N}}}.$$

1. When $N = 1$, we have

$$p^*(1) = r + \frac{R - r}{2} = \frac{r + R}{2} \text{ and } u(p^*(1)) = \frac{R - r}{4}.$$

2. When $N = 2$, we obtain

$$p^*(2) = r + \frac{R - r}{\sqrt{3}} \text{ and } u(p^*(2)) = (R - r) \frac{2\sqrt{3}}{9}.$$

3. As $N \rightarrow \infty$

$$p^*(\infty) = \lim_{N \rightarrow \infty} p^*(N) = \lim_{N \rightarrow \infty} r + \frac{R - r}{(N + 1)^{\frac{1}{N}}} = R$$

and $u(p^*(\infty)) = R - r$. To show the last equality, note that

$$\ln \lim_{N \rightarrow \infty} (N + 1)^{\frac{1}{N}} = \lim_{N \rightarrow \infty} \frac{1}{N} \ln(1 + N) = 0$$

so that

$$\lim_{N \rightarrow \infty} (N + 1)^{\frac{1}{N}} = 1.$$

When the number of buyers becomes very large, the optimal price should be set at the upper range of valuation.

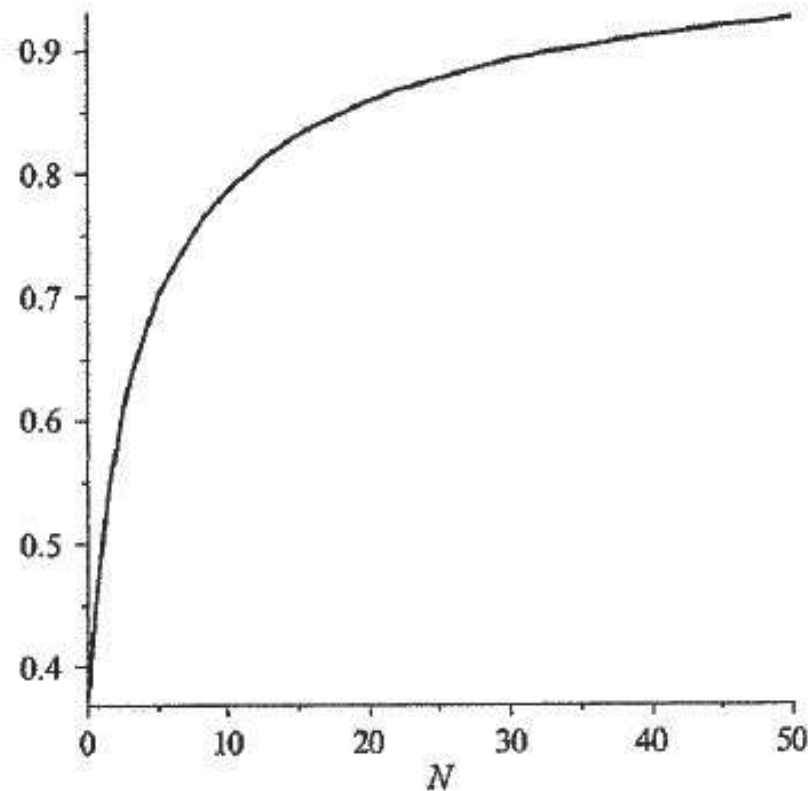

Take-it-or-leave-it price versus number of bidders.

Here, we choose $r = 0$ and $R = 1$. The buy-it-now price should be a discrete function of N (though the above plot shows continuous value of N).

Tragedy of the commons

This is an economic theory of a situation within a shared-resource system where individual users acting independently according to their own self-interest behave contrary to the common good of all users by depleting or spoiling that resource through their collective actions.

Typical examples of common resources are (1) fisheries in international waters, (2) ground water.

Suppose there are N farmers who share grazing land for sheep. Each of the farmers has the option of having one sheep. The payoff to a farmer for having one sheep is 1, but sheep damage the common grazing land at cost - 5 per sheep (shared by all the N farmers).

$$u_i(x_1, x_2, \dots, x_N) = x_i - 5 \frac{x_1 + x_2 + \dots + x_N}{N},$$
$$x_i = \begin{cases} 1 & \text{if } i \text{ has a sheep, } i = 1, 2, \dots, N, \\ 0 & \text{otherwise} \end{cases}.$$

Claim

If $N \geq 5$, a Nash equilibrium is $(1, 1, \dots, 1)$ and $u_i(1, 1, \dots, 1) = -4$ for each farmer. If farmer i decides not to have a sheep while everybody else sticks with their sheep, then

$$\begin{aligned} u_i(0, 1_{-i}) &= u_i(1, \dots, 1, 0, 1, \dots, 1) = 0 - 5 \frac{N-1}{N} \\ &= -5 + \frac{5}{N} \leq -4 = u_i(1, 1_{-i}), \end{aligned}$$

if and only if $N \geq 5$.

How to avoid this outcome? Impose a sheep tax α , where

$$u_i(x_1, \dots, x_N) = x_i - \alpha x_i - 5 \frac{x_1 + \dots + x_N}{N}.$$

If everyone has a sheep, $u_i(1, \dots, 1) = -4 - \alpha$. If $\alpha \geq 1$, it is seen that $u_i(0, 1_{-i}) > -5$ and player i is better off by getting rid of his sheep. The new Nash equilibrium is $(0, 0, \dots, 0)$ and no farmer has a sheep. Here, the tax has to be very strong with value higher or equal to the revenue.

Clean air as a common resource

Total amount of clean air is K , and any consumption of clean air comes out of this common resource. There are n players.

Each player i chooses his own consumption of clean air for production, $k_i \geq 0$. The amount of clean air left is $K - \sum_{j=1}^n k_j$.

The utility of consuming k_i is $\ln k_i$; and each player also enjoys consuming the remainder of the clean air, the utility of which is $\ln \left(K - \sum_{j=1}^n k_j \right)$. The payoff for player i is

$$u_i(k_i, k_{-i}) = \ln k_i + \ln \left(K - \sum_{j=1}^n k_j \right).$$

One may choose different weights on the contributions to the total utility u_i from the personal consumption and the consumption of the remaining clean air.

Given others' consumptions k_{-i} , player i wants to choose an element in $B_i(k_{-i})$. If we find some profile of choices $(k_1^*, k_2^*, \dots, k_n^*)$ for which $k_i^* = B_i(k_{-i}^*)$, for all i , then this must be a Nash equilibrium.

We start with deriving all n best-response functions, then we have a system of n equations, one for each player's best response function, with n unknowns (the choices of each player). Solving this system yields a Nash equilibrium.

We write down the first order condition of player's i payoff:

$$\frac{\partial u_i}{\partial k_i}(k_i, k_{-i}) = \frac{1}{k_i} - \frac{1}{K - \sum_{j=1}^n k_j} = 0,$$

giving

$$B_i(k_{-i}) = \frac{K - \sum_{j \neq i} k_j}{2}.$$

When $N = 2$, we obtain

$$k_1(k_2) = \frac{K - k_2}{2} \quad \text{and} \quad k_2(k_1) = \frac{K - k_1}{2}.$$

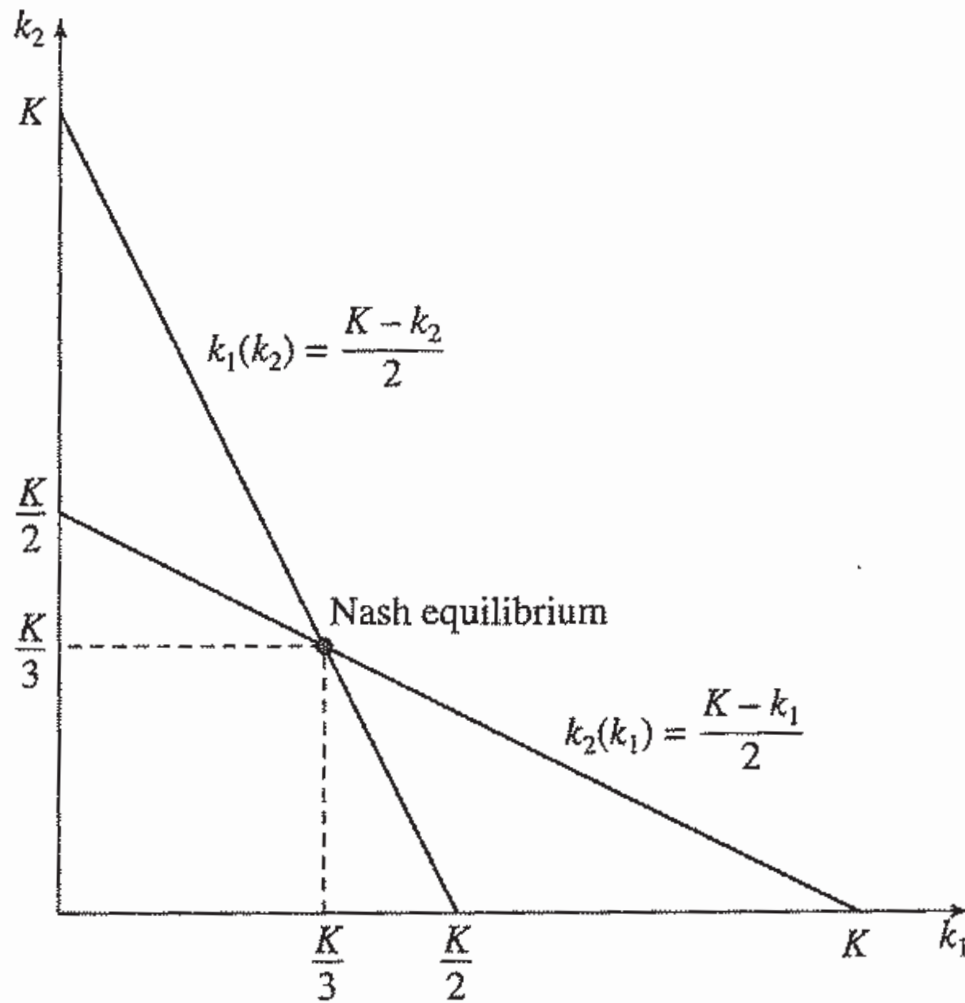

Best-response functions: two-player tragedy of the commons.

The unique Nash equilibrium for this two-player game is $k_1 = k_2 = \frac{K}{3}$.

From the Pareto criterion, can we find another consumption profile that will make everyone better off?

In general, maximizing the sum of utility functions, or maximizing the total welfare, will result in a Pareto-optimal outcome (cannot achieve the gain of one player without hurting the other player). In this example, the maximization gives the symmetric Pareto-optimal consumption profile. We solve

$$\max_{k_1, k_2} w(k_1, k_2) = \sum_{i=1}^2 u_i(k_1, k_2) = \sum_{i=1}^2 \ln k_i + 2 \ln \left(K - \sum_{i=1}^2 k_i \right).$$

The first order conditions are

$$\begin{aligned} \frac{\partial w(k_1, k_2)}{\partial k_1} &= \frac{1}{k_1} - \frac{2}{K - k_1 - k_2} = 0, \\ \frac{\partial w(k_1, k_2)}{\partial k_2} &= \frac{1}{k_2} - \frac{2}{K - k_1 - k_2} = 0. \end{aligned}$$

Unlike an individual player i who can control k_i only, the social planner can control k_1 and k_2 to achieve the maximum of $w(k_1, k_2)$.

The unique solution to these two equations yields $k_1 = k_2 = \frac{K}{4}$, which means that from a social point of view the Nash equilibrium has the two players each consuming too much clean air. Indeed, the total welfare would be better off if each consumes $k_i = \frac{K}{4}$ instead of $k_i = \frac{K}{3}$.

Thus, giving people the freedom to make choices may make them all worse off than if those choices were somehow regulated. Of course the counterargument is whether we can trust a regulator to keep things under control. If not, the question remains which is the better of the two evils – an answer that this simple game model cannot offer!

3.2 Economic applications

Cournot duopoly: Competition between two firms

Two firms are producing the same product with quantity $q_i \geq 0$, $i = 1, 2$; so the total quantity produced is $q = q_1 + q_2$. We assume q to be any non-negative real number. That is, the quantity is infinitely divisible, like petroleum. The firms seek to maximize their individual profit given their competitors' decisions.

Let $P(q)$ be the price of one unit of the product when q units are produced. First, we consider a simple linearly decreasing price function with respect to total quantities produced, where

$$P(q) = (\Gamma - q)^+ = \begin{cases} \Gamma - q & \text{if } 0 \leq q \leq \Gamma, \\ 0 & \text{if } q > \Gamma. \end{cases}$$

The profit functions of the two firms are

$$u_1(q_1, q_2) = P(q_1 + q_2)q_1 - c_1q_1 \text{ and } u_2(q_1, q_2) = P(q_1 + q_2)q_2 - c_2q_2,$$

where c_i is the cost per unit produced for firm i , $i = 1, 2$. The interaction between the two profit functions is through the common price function $P(q_1 + q_2)$. The complete knowledge of the costs of production is assumed to be known to all competing firms.

- How does the outcome of the competition depend on the demand of the firms' output (Γ in the price function) and the firms' cost functions? What would be the optimal production level under various assumptions?

According to the notion of a Nash equilibrium, we are not trying to maximize each profit function over both variables, but each profit function to each firm as a function only of the variable it controls, namely, q_i .

We take the partial of u_i with respect to q_i , not the partial of each payoff function with respect to both variables. The first order conditions lead to

$$\begin{aligned}\frac{\partial u_1}{\partial q_1} = 0 &\Rightarrow -2q_1 - q_2 + \Gamma - c_1 = 0, \\ \frac{\partial u_2}{\partial q_2} = 0 &\Rightarrow -2q_2 - q_1 + \Gamma - c_2 = 0.\end{aligned}$$

Recall that $\frac{\partial u_1}{\partial q_1} = 0$ gives the best response function $q_1(q_2)$, and similarly for $\frac{\partial u_2}{\partial q_2} = 0$. We seek for the Nash strategy profile (q_1^*, q_2^*) that satisfies both equations simultaneously.

The best response functions are given by

$$q_1(q_2) = \frac{\Gamma - c_1 - q_2}{2} \text{ and } q_2(q_1) = \frac{\Gamma - c_2 - q_1}{2}.$$

The intersection of these two best responses gives the Nash equilibrium production quantities as

$$q_1^* = \frac{\Gamma + c_2 - 2c_1}{3} \text{ and } q_2^* = \frac{\Gamma + c_1 - 2c_2}{3}.$$

For sufficient conditions, provided that $\Gamma > 2c_1$ and $\Gamma > 2c_2$ (the costs are low compared to the maximum quantity Γ), we have $q_1^* > 0$ and $q_2^* > 0$. Checking the second order conditions, we observe

$$\frac{\partial^2 u_1}{\partial q_1^2}(q_1^*, q_2^*) = -2 < 0 \text{ and } \frac{\partial^2 u_2}{\partial q_2^2}(q_1^*, q_2^*) = -2 < 0,$$

so (q_1^*, q_2^*) are the values that maximize the individual profit functions, when the other player plays its part of the Nash equilibrium.

The total quantities produced at the Nash equilibrium is given by

$$q^* = q_1^* + q_2^* = \frac{2\Gamma - c_1 - c_2}{3} > 0 \text{ if } \Gamma > 2c_1 \text{ and } \Gamma > 2c_2.$$

At the Nash equilibrium, both firms produce the quantities of product according to their Nash strategies. The equilibrium price at q^* is

$$P(q_1^* + q_2^*) = \Gamma - q_1^* - q_2^* = \Gamma - \frac{2\Gamma - c_1 - c_2}{3} = \frac{\Gamma + c_1 + c_2}{3}.$$

For $q_1^* > 0$ and $q_2^* > 0$, the profit functions are

$$u_1(q_1^*, q_2^*) = \frac{(\Gamma + c_2 - 2c_1)^2}{9} \text{ and } u_2(q_1^*, q_2^*) = \frac{(\Gamma + c_1 - 2c_2)^2}{9}.$$

The profit function for firm 1 at Nash equilibrium is increasing in c_2 . When c_2 is larger, the opponent firm is less competitive, so u_1 increases.

Degenerate case

When $2c_1 > \Gamma + c_2$, firm 1 is not competitive since its cost per unit is too high, giving $q_1^* < 0$. Since the profit function u_1 is concave in q_1 with local maximum at negative q_1 . To satisfy non-negativity condition on q_1 , firm 1 takes $q_1^* = 0$. The new Nash equilibrium point is given by

$$q_1^* = 0 \text{ and } q_2^* = \frac{\Gamma - c_2}{2}.$$

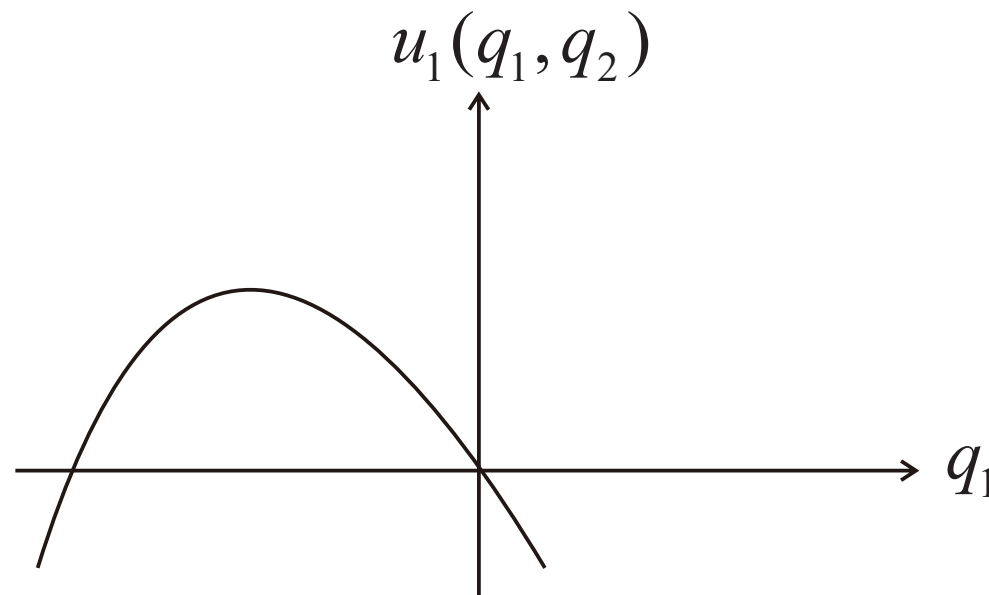

To verify that $\left(0, \frac{\Gamma - c_2}{2}\right)$ is a Nash equilibrium when $2c_1 > \Gamma + c_2$, it suffices to show

$$\begin{aligned}
 \text{(i) } u_1\left(q_1, \frac{\Gamma - c_2}{2}\right) &= \left(\Gamma - \frac{\Gamma - c_2}{2} - q_1\right)q_1 - c_1q_1 \\
 &= -\frac{2c_1 - \Gamma - c_2}{2}q_1 - q_1^2 \\
 &\leq u_1\left(0, \frac{\Gamma - c_2}{2}\right) = 0 \text{ for } q_1 \geq 0.
 \end{aligned}$$

$$\text{(ii) } u_2(0, q_2) = (\Gamma - q_2)q_2 - c_2q_2 \text{ which is maximized at } q_2 = \frac{\Gamma - c_2}{2}.$$

Iterated elimination of strictly dominated strategies (IESDS)

We show how to achieve the Nash equilibrium using the notion of iterated elimination of strictly dominated strategies.

As a numerical example, let the price be given by $P(q) = 100 - q$, where $q = q_1 + q_2$, and $\Gamma = 100$, $c_1 = c_2 = 10$. Consider the profit function of firm 1:

$$u_1(q_1, q_2) = (100 - q_1 - q_2)q_1 - 10q_1 = 90q_1 - q_1^2 - q_1q_2.$$

The best response function of firm 1 is

$$q_1(q_2) = \frac{90 - q_2}{2}. \quad (\text{i})$$

Since q_2 is never negative, in which case equation (i) implies that $q_1 \leq 45$.

By symmetry, firm 2 has exactly the same form of the best response function, where

$$q_2(q_1) = \frac{90 - q_1}{2}. \quad (\text{ii})$$

First round of iterated elimination

Indeed, any quantity $q_1 > 45$ is strictly dominated by $q_1 = 45$. To see this result, we consider

$$\begin{aligned}u_1(45, q_2) - u_1(q_1, q_2) &= 2025 - 45q_2 - (90q_1 - q_1q_2 - q_1^2) \\ &= 2025 - q_1(90 - q_1) - q_2(45 - q_1).\end{aligned}$$

The last term $-q_2(45 - q_1)$ is positive for $q_1 > 45$ and $q_2 > 0$, the sum of the first two terms $2025 - q_1(90 - q_1) = q_1^2 - 90q_1 + 2025$ is minimized at $q_1 = 45$ and the corresponding minimum value is zero. Therefore, any $q_1 > 45$, this difference is positive regardless of the value of q_2 . Hence, we conclude that any $q_1 > 45$ is strictly dominated by $q_1 = 45$.

Since firm 2 faces exactly the same profit function, which implies that any $q_2 > 45$ is strictly dominated by $q_2 = 45$. This leads to our first round of iterated elimination: a rational firm produces no more than 45 units, implying that the effective strategy space that survives one round of elimination is $q_i \in [0, 45]$ for $i \in \{1, 2\}$.

Second round of iterated elimination

Since $q_2 \leq 45$, equation (i) implies that firm 1 will choose a quantity no less than 22.5, and a symmetric argument applies to firm 2. The second round of elimination implies that the surviving strategy sets are $q_i \in [22.5, 45]$ for $i \in \{1, 2\}$. This is illustrated by the vertical line segment at $q_2 = 45$ bounded between the two lines: $q_1 = q_2$ and $q_1 = \frac{90 - q_2}{2}$.

The next step of this process reduces the strategy set to $q_i \in [22.5, 33.75]$, and the process will continue on and on. The set of strategies that survives this process converges to a single quantity choice of $q_i = 30$.

By symmetry of the two firms, both firms share the same interval of $[q_{\min}^{(k)}, q_{\max}^{(k)}]$ in the k^{th} iteration, independent of $i = 1, 2$.

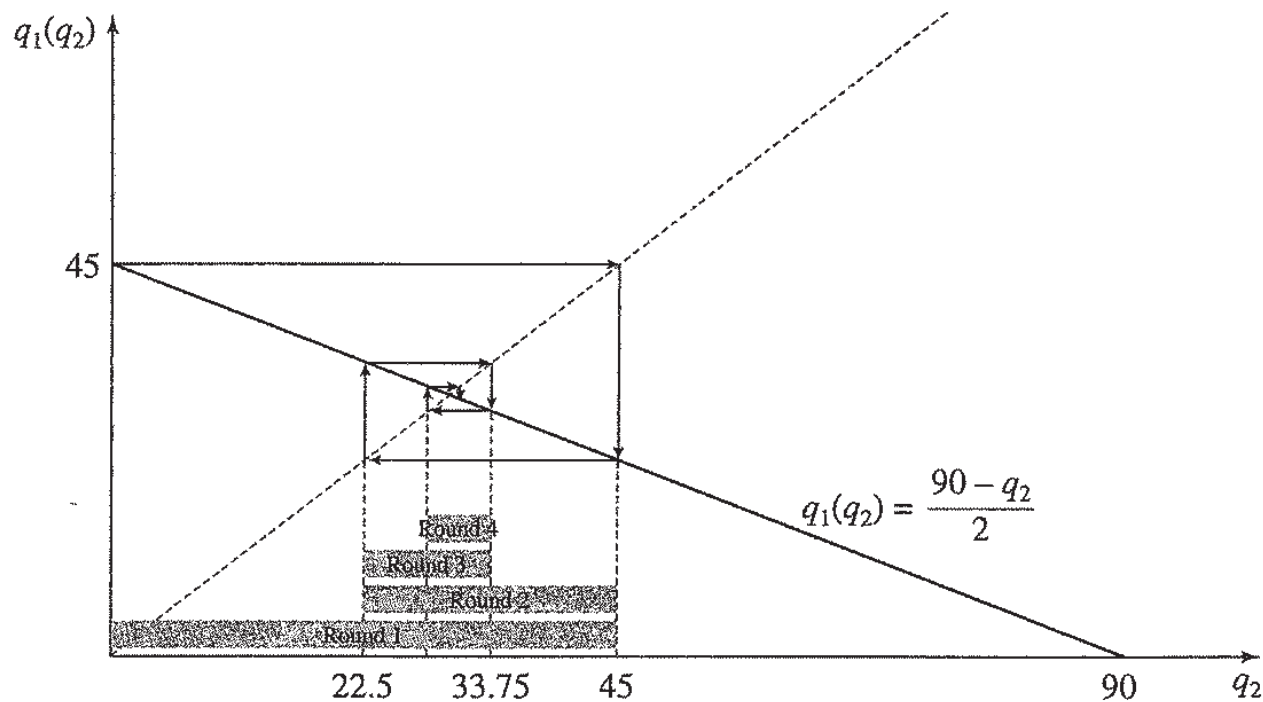

IESDS convergence in the Cournot game.

$$q_{\min}^{(k+1)} = \frac{90 - q_{\max}^{(k)}}{2} \quad \text{and} \quad q_{\max}^{(k+2)} = \frac{90 - q_{\min}^{(k+1)}}{2}.$$

$[q_{\min}^{(1)}, q_{\max}^{(1)}] = [0, 45]$, $[q_{\min}^{(2)}, q_{\max}^{(2)}] = [22.5, 45]$, $[q_{\min}^{(3)}, q_{\max}^{(3)}] = [22.5, 33.75]$,
 etc.

We can see this process graphically (see figure), where we use the upper (lower) end of the previous interval to determine the lower (upper) end of the next one. For example, we have

$$q_{\min}^{(2)} = \frac{90 - q_{\max}^{(1)}}{2} = \frac{90 - 45}{2} = 22.5;$$
$$q_{\max}^{(2)} = \frac{90 - q_{\min}^{(1)}}{2} = \frac{90}{2} = 45.$$

If this were to converge to an interval and not to a single point, then by the symmetry between both firms, the resulting interval for each firm would be $[q_{\min}, q_{\max}]$.

In the limit, q_{\min} and q_{\max} simultaneously satisfy two equations with two unknowns: $q_{\min} = \frac{90 - q_{\max}}{2}$ and $q_{\max} = \frac{90 - q_{\min}}{2}$.

However, the only solution to these two equations is $q_{\min} = q_{\max} = 30$, so the interval reduces to a single point: $(q_1^*, q_2^*) = (30, 30)$.

Hence using Iterated Elimination of Strictly Dominated Strategies for the Cournot game results in a unique predictor of behavior where $q_1^* = q_2^* = 30$, and each firm earns a profit of $u_1 = u_2 = 900$.

Comparison of Nash equilibrium with collusive outcomes

Is there any pair of outputs at which both firms' profits exceed their levels in a Nash equilibrium?

Suppose the two firms form a cartel and collude to set $q_1 = q_2$ and we write $Q = q_1 + q_2$ as the total output. The sum of profits of the two firms is

$$\begin{aligned}u_{\text{total}}(Q) &= u_1\left(\frac{Q}{2}, \frac{Q}{2}\right) + u_2\left(\frac{Q}{2}, \frac{Q}{2}\right) \\&= P(Q)\frac{Q}{2} - c_1\frac{Q}{2} + P(Q)\frac{Q}{2} - c_2\frac{Q}{2} \\&= (\Gamma - Q)Q - \frac{c_1 + c_2}{2}Q = \left(\Gamma - \frac{c_1 + c_2}{2}\right)Q - Q^2.\end{aligned}$$

To find Q such that $u_{\text{total}}(Q)$ is maximized, we consider the first order condition

$$\frac{du_{\text{total}}(Q)}{dQ} = 0.$$

This gives $\Gamma - 2Q - \frac{c_1 + c_2}{2} = 0$ or $Q^* = \frac{\Gamma}{2} - \frac{c_1 + c_2}{4}$, provided $\Gamma > \frac{c_1 + c_2}{2}$.

The corresponding values of the two firms at Q^* are given by

$$u_1 \left(\frac{Q^*}{2}, \frac{Q^*}{2} \right) = (\Gamma - Q^*) \frac{Q^*}{2} - c_1 \frac{Q^*}{2} = \left(\frac{\Gamma}{2} - \frac{3c_1 - c_2}{4} \right) \frac{Q^*}{2} > u_1(q_1^*, q_2^*)$$

$$u_2 \left(\frac{Q^*}{2}, \frac{Q^*}{2} \right) = (\Gamma - Q^*) \frac{Q^*}{2} - c_2 \frac{Q^*}{2} = \left(\frac{\Gamma}{2} - \frac{3c_2 - c_1}{4} \right) \frac{Q^*}{2} > u_2(q_1^*, q_2^*).$$

Unfortunately, the collusive outcome is not a Nash equilibrium. That is, it is possible that firm 1's (firm 2's) profit can be increased further by deviating from $\frac{Q^*}{2}$ while firm 2 (firm 1) keeps the output to be $\frac{Q^*}{2}$. In that sense, the formation of a cartel is unstable since the collusion agreement is not binding.

The pair (q_1^*, q_2^*) is a Nash equilibrium. When player 2 chooses q_2^* and player 1 deviates from q_1^* , firm 1's profit decreases (see the horizontal dotted line which is above the isoprofit curve of firm 1).

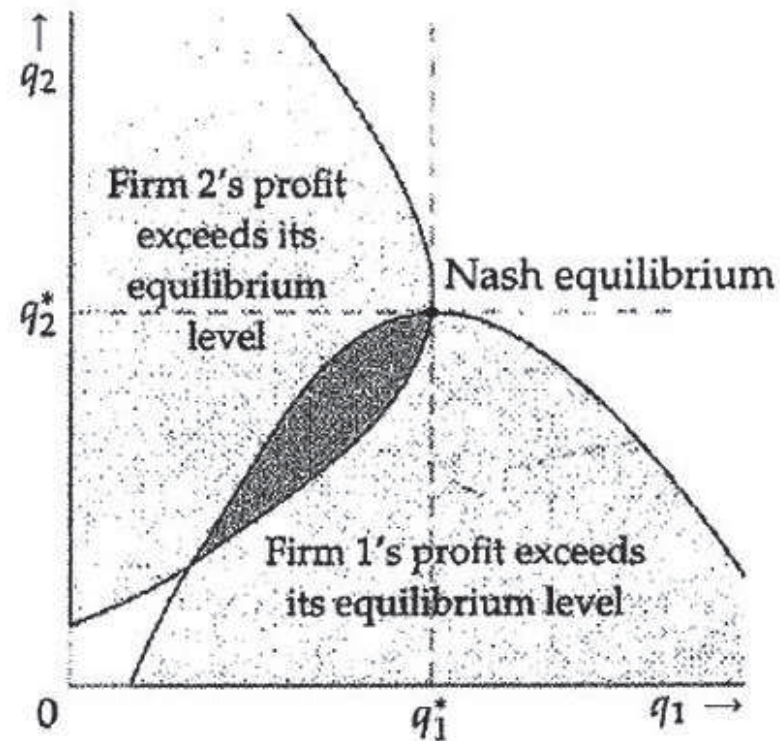

The plotted isoprofit curve of firm 1 shows the points (q_1, q_2) such that $u_1(q_1, q_2) = u_1(q_1^*, q_2^*)$. The area shaded dark gray is the set of pairs of outputs at which both firms' profits exceed those from their Nash equilibrium levels.

Explanation

There are infinitely many isoprofit curves in the q_1 - q_2 plane. The Nash equilibrium point is the interaction point of the two tips of the specific pair of isoprofit curves.

The points that lie below the isoprofit curve of firm 1 give higher profit level than that of the equilibrium (q_1^*, q_2^*) . For example, suppose q_1 is fixed while q_2 decreases in value, the price is increasing with total quantities produced decreases. Therefore, profit of firm 1 increases.

Similarly, the set of pairs of outputs at which firm 2's profit is at least its equilibrium profit lies on or to the left of the isoprofit curve of firm 2.

The intersection of these two regions give the pairs of outputs in which $q_1 \leq q_1^*$ and $q_2 \leq q_2^*$ while $u_1(q_1, q_2) \geq u_1(q_1^*, q_2^*)$ and $u_2(q_1, q_2) \geq u_2(q_1^*, q_2^*)$.

Generalization: using common property

Recall that the profit function of each firm i is

$$q_i P(q_1 + q_2 + \dots + q_n) - c_i(q_i),$$

where c_i may be a function of q_i . Each firm's payoff depends only on its output and the sum of all the firm's outputs. These profit functions share the same $P(q_1 + q_2 + \dots + q_n)$.

The more general payoff of firm i may be $f_i(q_i, q_1 + q_2 + \dots + q_n)$, where f_i is decreasing in its second argument (since the price drops with increasing total quantities produced).

This more general payoff function captures situations in which players compete in using a piece of common property whose value to any one player diminishes as the total use increases. The common property may be a village green, where the higher the total number of sheep grazed there, the less valuable the green is to any given farmer.

Stackelberg model (leader-follower model)

The leader firm, firm 1, announces its production quantity publicly, then the follower firm, firm 2 decides how much to produce. Recall the profit function of the two firms are given by (same as those of the Cournot model)

$$\begin{aligned}u_1(q_1, q_2) &= (\Gamma - q_1 - q_2)q_1 - c_1q_1, \\u_2(q_1, q_2) &= (\Gamma - q_1 - q_2)q_2 - c_2q_2.\end{aligned}$$

In the current model, we take q_1 as announced by firm 1 (leader firm). The order of move matters, and rational actions of the two firms should take this into account.

Since firm 2 observes q_1 , there is an optimal choice of firm 2 for every choice of q_1 by firm 1. We seek for the best response of firm 2 to the production announcement by firm 1. That is, firm 2 chooses $q_2 = q_2(q_1)$ so as to

maximize over q_2 , given q_1 , the function $u_2(q_1, q_2(q_1))$.

By setting $\frac{\partial u_2}{\partial q_2} = 0$, we obtain

$$q_2(q_1) = \frac{\Gamma - q_1 - c_2}{2}.$$

This follows the backward induction procedure where the optimal action of the follower firm is determined first.

Firm 1 knows what firm 2's optimal production quantity should be, given its own announcement of q_1 . Hence, firm 1 should choose q_1 to maximize its own profit function knowing that firm 2 will use its best response production quantity $q_2(q_1)$:

$$\begin{aligned}
 u_1(q_1, q_2(q_1)) &= q_1[\Gamma - q_1 - q_2(q_1)] - c_1q_1 \\
 &= q_1\left(\Gamma - q_1 - \frac{\Gamma - q_1 - c_2}{2}\right) - c_1q_1 \\
 &= q_1\frac{\Gamma - q_1}{2} + q_1\left(\frac{c_2}{2} - c_1\right).
 \end{aligned}$$

This is different from the simultaneous moves in the Cournot game model, under which the optimal choice of q_1 is made based on some belief on q_2 . Here, firm 1 does not need to conjecture a belief on q_2 .

Firm 1 chooses q_1 in order to make $u_1(q_1, q_2(q_1))$ to be maximized, where

$$u_1(q_1, q_2(q_1)) = \left(\Gamma - q_1 - \frac{\Gamma - q_1 - c_2}{2} \right) q_1 - c_1 q_1.$$

Setting $\frac{\partial u_1}{\partial q_1} = 0$ gives

$$q_1^* = \frac{\Gamma - 2c_1 + c_2}{2}.$$

Given q_1^* , the optimal production quantity for firm 2 is

$$q_2^* = q_2(q_1^*) = \frac{\Gamma + 2c_1 - 3c_2}{4}.$$

The equilibrium profit functions for the two firms are

$$u_2(q_1^*, q_2^*) = \frac{(\Gamma + 2c_1 - 3c_2)^2}{16} \quad \text{and} \quad u_1(q_1^*, q_2^*) = \frac{(\Gamma - 2c_1 + c_2)^2}{8}.$$

Symmetric costs for both firms

Suppose we set $c_1 = c_2 = c$ for comparison with the Cournot model. We obtain

$$q_1^C = \frac{\Gamma - c}{3} \text{ and } q_2^C = \frac{\Gamma - c}{3}.$$

The equilibrium profit functions are

$$u_1(q_1^C, q_2^C) = \frac{(\Gamma - c)^2}{9} \text{ and } u_2(q_1^C, q_2^C) = \frac{(\Gamma - c)^2}{9}.$$

In the Stackelberg model, we have

$$q_1^* = \frac{\Gamma - c}{2} > q_1^C \text{ and } q_2^* = \frac{\Gamma - c}{4} < q_2^C.$$

Therefore, firm 1 produces more and firm 2 produces less under the Stackelberg model.

How about firms' profits, total quantity produced and price at equilibrium?

Firms' profits

$$u_1(q_1^C, q_2^C) = \frac{(\Gamma - c)^2}{9} < u_1(q_1^*, q_2^*) = \frac{(\Gamma - c)^2}{8},$$
$$u_2(q_1^C, q_2^C) = \frac{(\Gamma - c)^2}{9} > u_2(q_1^*, q_2^*) = \frac{(\Gamma - c)^2}{16}.$$

Total quantities produced

$$q_1^C + q_2^C = \frac{2}{3}(\Gamma - c) < q_1^* + q_2^* = \frac{3}{4}(\Gamma - c).$$

Price at equilibrium ($\Gamma > c$)

$$P(q_1^* + q_2^*) = \frac{\Gamma + 3c}{4} < P(q_1^C + q_2^C) = \frac{\Gamma + 2c}{3}.$$

With more total quantities produced at a lower price, the social welfare is enhanced.

Remarks

1. In the Stackelberg game, firm 1 chooses its quantity given the best response curve of firm 2. The leader has a higher profit (first mover advantage) since firm 1 could have always obtained the Cournot profit by choosing q_1^C to which firm 2 has to reply with q_2^C . The leader knows that by increasing q_1 , the follower will reduce q_2 .
2. When the firms are symmetric (both firms have the same cost), then the Stackelberg solution leads to better social welfare than that of the Cournot model (higher total quantity and lower price). This may not be the case when the leader is the less efficient firm (higher cost). In other words, giving advantage to the less competitive firm may harm the society.

Entry deterrence problem

If there is currently only one firm producing the product, what should be the price of the product in order to make it unprofitable for another firm to enter the market?

Before the challenger enters the market, the profit function of the incumbent firm 1 under monopoly is

$$u_1(q_1) = (\Gamma - q_1)q_1 - (aq_1 + b),$$

where the cost function $c(q) = aq + b$, with $\Gamma > a$, $b > 0$. The cost function includes a fixed cost of $b > 0$. Actually, without b , there will be no good story to be told in this model.

Suppose firm 1 maximizes its profit, the corresponding production quantity is

$$q_1^* = \frac{\Gamma - a}{2}.$$

The maximum profit for the monopolist is

$$u_1(q_1^*) = \frac{(\Gamma - a)^2}{4} - b.$$

The price of the product at this quantity of production will be

$$p = D(q_1^*) = \Gamma - q_1^* = \frac{\Gamma + a}{2}.$$

Now, firm 2 enters and calculates its profit function based on $q_1^* = \frac{\Gamma - a}{2}$. This gives

$$u_2(q_2) = \left(\Gamma - \frac{\Gamma - a}{2} - q_2\right)q_2 - (aq_2 + b).$$

We may consider the incumbent firm as the leader and the entrant firm as the follower. Firm 2 calculates its maximum possible profit and optimal production quantity as

$$u_2(q_2^*) = \frac{(\Gamma - a)^2}{16} - b, \text{ where } q_2^* = \frac{\Gamma - a}{4}.$$

The price of the product now drops to

$$p = D(q_1^* + q_2^*) = \Gamma - q_1^* - q_2^* = \frac{\Gamma + 3a}{4} < D(q_1^*) = \frac{\Gamma + a}{2}.$$

As long as $u_2(q_2^*) > 0$, firm 2 has an incentive to enter the market. This would require

$$\frac{(\Gamma - a)^2}{16} > b.$$

There are two choices for the incumbent firm.

1. Readjusted q_1 so as to maximize $u_1(q_1, q_2(q_1))$.
2. Deter the entry of the new firm. How?

Firm 1 adjusts q_1 to drive firm 2's profit to zero

Firm 1 is not about to sit by idly and let another firm enter the market. It looks at the profit function of firm 2, where

$$u_2(q_1, q_2) = (\Gamma - q_1 - q_2)q_2 - (aq_2 + b).$$

Firm 2 would maximize this as a function of q_2 to obtain

$$q_2^m = \frac{\Gamma - q_1 - a}{2} \text{ and } u_2(q_1, q_2^m) = \frac{(\Gamma - q_1 - a)^2}{4} - b.$$

Firm 1 may reason that it can set q_1 so that firm 2's profit is driven to zero. We find q_1^0 such that $u_2(q_1^0, q_2^m) = 0$; that is,

$$u_2(q_1, q_2^m) = \frac{(\Gamma - q_1 - a)^2}{4} - b = 0 \Rightarrow q_1^0 = \Gamma - 2\sqrt{b} - a.$$

The price at q_1^0 is $D(q_1^0) = \Gamma - (\Gamma - 2\sqrt{b} - a) = 2\sqrt{b} + a$, and the profit for firm 1 is

$$u_1(q_1^0) = (\Gamma - q_1^0)q_1^0 - (aq_1^0 + b) = 2\sqrt{b}(\Gamma - a) - 5b,$$

To ensure $u_1(q_1^0) > 0$, we require $\Gamma > a + \frac{5}{2}\sqrt{b}$.

3.3 Auctions

There are many possible designs (or sets of rules) for an auction and typical issues studied include equilibrium bidding strategies and revenue comparison.

Auctions take many forms but always satisfy two conditions:

1. They may be used to sell any item and so are *universal*.
2. The outcome of the auction does not depend on the identity of the bidders; that is, auctions are *anonymous*.

Most auctions have the feature that participants submit *bids*, amounts of money they are willing to pay. *Standard* auctions specify the winner of the auction to be the participant with the highest bid. A *nonstandard* auction does not require this (for example, inclusion of lottery draw among the top bidders).

Clock feature: The auction is run during a fixed time interval, which may affect the bidders' strategies. We expect a rush of bid orders near the closing time.

Four types of auctions: sealed-bid or open; first-price or second-price; descending or ascending

- *First-price sealed-bid auctions* in which bidders place their bid in a sealed envelope and simultaneously hand them to the auctioneer. The envelopes are opened and the individual with the highest bid wins, paying the amount bid.
- *Second-price sealed-bid auctions (Vickrey auctions)* in which bidders place their bid in a sealed envelope and simultaneously hand them to the auctioneer. The envelopes are opened and the individual with the highest bid wins, paying a price equal to the *second-highest* bid. Later, we show that the Vickrey auction promotes truthful bidding. It was used in an auction for stamp collector in 1893.
- *Open descending-bid auctions (Dutch auctions)* in which the price is set by the auctioneer at a level sufficiently high to deter all bidders, and is progressively lowered until a bidder is prepared to buy at the current price, winning the auction.

In a Dutch auction, bidders know nothing about the bids of others, other than the fact that no one has yet accepted the current price. There is the highest bid that breaks the silence and wins the auction. Therefore, it is equivalent to the first-price sealed-bid auction.

- *Open ascending-bid auctions (English auctions)* in which participants make increasingly higher bids. This continues until no participant is prepared to make a higher bid. The highest bidder wins the auction at the final amount bid. Sometimes the item is only actually sold if the bidding reaches a reserve price set by the seller. The auction helps the seller exploit the surplus between the highest bid and the reserve price.

In an English auction, the bidder with the highest valuation wins the auction and pays an amount slightly higher than the value of the second highest bidder provided each bid goes up by small amount. It has close similarity with the second-price sealed-bid auction except that it involves real time interaction between the bidders. The information collected from bidding prices going up may affect the bidders' valuation of the item psychologically (allowance for price discovery).

Symmetric and independent personal valuations among bidders

- The bidder knows her own private value but those of the competing bidders are drawn from known probability distributions.
- Symmetric bidders means the probability distribution from which the bidders obtain their values is *identical across bidders*.

We assume independent and identical distribution of the bidders' valuations, where

$$P[V_1 \leq v_1, V_2 \leq v_2, \dots, V_N \leq v_N] = F(v_1)F(v_2)\dots F(v_N).$$

The bidders know their own valuations of the object but not the valuations of the other bidders. They are symmetric in the sense that they share the same valuation distribution.

Furthermore, we assume uniform distribution to enhance analytical tractability. Without loss of generality, we assume the bidders' valuations to be uniform on $[0, 1]$ (we can always normalize $[r, R]$ to $[0, 1]$) so that

$$F(v) = \begin{cases} 0 & \text{if } v < 0 \\ v & \text{if } 0 \leq v \leq 1 \\ 1 & \text{if } v > 1 \end{cases} .$$

By symmetry of the bidders, all bidders share the same optimal bidding function based on the same optimal strategy. For each bidder, she maximizes her expected payoff by choosing a bidding strategy $\beta(v)$.

Dutch auction

The truthful bidding strategy $b_i = v_i$ is a dominated strategy since the payoff is always zero (independent of winning or not winning). It is dominated by $b_i < v_i$ since there always exists a finite probability of winning with winning payoff $v_i - b_i$.

Consider player 1 whose bid is $b = \beta(v)$ (all players are indistinguishable), the probability that she wins the object is

$$P[\beta(\max\{V_2, \dots, V_N\}) < b].$$

Note that β is strictly increasing in v since higher valuation leads to higher bid, so $\beta^{-1}(b)$ exists. Since all valuations are independent and identically distributed, assuming uniform distribution, the probability of winning by player 1 is

$$\begin{aligned} f(b) &= P[\max\{V_2, \dots, V_N\} < \beta^{-1}(b)] \\ &= P[V_i < \beta^{-1}(b), \quad i = 2, \dots, N] \\ &= F(\beta^{-1}(b))^{N-1} = [\beta^{-1}(b)]^{N-1}. \end{aligned}$$

Note that v is the personal valuation value of player 1, a known quantity to player 1. For the given v , player 1 chooses b to maximize her expected payoff as given by

$$u(b; v) = (v - b)f(b).$$

Taking the derivative of $u(b; v)$ with respect to the choice variable b and setting to zero for the given valuation v . By keeping v fixed [should not set $v = \beta^{-1}(b)$ at this point], the first order condition is given by

$$f'(b)(v - b) - f(b) = 0.$$

Since $f(b) = [\beta^{-1}(b)]^{N-1}$, we have

$$\frac{df(b)}{db} = (N - 1)[\beta^{-1}(b)]^{N-2} \frac{d\beta^{-1}(b)}{db}.$$

Optimality of the choice of b dictates that the first order condition is satisfied at $v = \beta^{-1}(b)$. After dividing out the term $[\beta^{-1}(b)]^{N-2}$, the first order condition evaluated at $v = \beta^{-1}(b)$ becomes

$$(N - 1)[\beta^{-1}(b) - b] \frac{d\beta^{-1}(b)}{db} - \beta^{-1}(b) = 0.$$

Writing $y(b) = \beta^{-1}(b)$ for notational convenience, the governing differential equation becomes

$$(N - 1)[y(b) - b]y'(b) - y(b) = 0,$$

with initial condition: $y(0) = 0$ [since $\beta(0) = 0$]. This is a first-order ordinary differential equation for $y(b)$.

One good guess of the solution is to consider $y = \alpha b$ for some constant α . Substituting into the differential equation, we have

$$(N - 1)[\alpha b - b]\alpha - \alpha b = 0.$$

This gives

$$(N - 1)(\alpha - 1) = 1 \text{ or } \alpha = 1 + \frac{1}{N - 1} = \frac{N}{N - 1},$$

so that

$$y(b) = \beta^{-1}(b) = \frac{N}{N - 1}b.$$

Once we have obtained $y(b)$, we finally set $v = \beta^{-1}(b) = y(b)$ to obtain

$$b = \beta(v) = \left(1 - \frac{1}{N}\right)v,$$

which is the *optimal bidding function in a Dutch auction*. Note that b_1 is an increasing function of N , with $b = \frac{v}{2}$ when $N = 2$ and $b = v$ when $N \rightarrow \infty$.

For a given personal valuation v known to the bidder, she chooses the optimal bidding strategy $\left(1 - \frac{1}{N}\right)v$. She wins the auction if her valuation is the highest among all N bidders and places the bid when the price is gradually lowered to $\left(1 - \frac{1}{N}\right)v$.

It is seen that the Dutch auction and the first price sealed-bid auction are strategically equivalent.

Expected revenue received by the seller

In a Dutch auction, we know that the payment will be the highest bid given by $\beta(\max\{V_1, \dots, V_N\})$, which is the optimal bidding function evaluated at the largest of the random valuations. The expected seller's revenue is given by

$$\begin{aligned} E[\beta(\max\{V_1, \dots, V_N\})] &= E[(1 - \frac{1}{N})\max\{V_1, \dots, V_N\}] \\ &= (1 - \frac{1}{N})E[\max\{V_1, \dots, V_N\}] \\ &= \frac{N - 1}{N + 1}, \end{aligned}$$

since $E[\max\{V_1, \dots, V_N\}] = \frac{N}{N+1}$ when the V_i values are uniformly distributed on $[0, 1]$.

Proof of $E[\max\{V_1, \dots, V_N\}] = \frac{N}{N+1}$

Since the valuations are independent and all have the same distribution, the cumulative distribution function of $Y = \max\{V_1, \dots, V_N\}$ is

$$F_Y(x) = P[\max\{V_1, \dots, V_N\} \leq x] = P[V_i \leq x]^N = F_V(x)^N.$$

The density of Y is

$$f_Y(x) = F'_Y(x) = N(F_V(x))^{N-1} f_V(x).$$

When V has a uniform distribution on $[0, 1]$, $f_V(x) = 1$, $F_V(x) = x$, $0 < x < 1$, and so

$$f_Y(x) = Nx^{N-1}, \quad 0 < x < 1.$$

We then obtain

$$E[Y] = \int_0^1 x f_Y(x) \, dx = \frac{N}{N+1}.$$

English auction

Assuming that bidders do not change their valuations based on the other bidders' bids, then bidders should accept to pay any price up to their own valuations. A player will continue to bid until the current announced bid price is greater than his personal valuation. Note that negative payoff may be resulted if the bid is higher than one's valuation.

The item will be won by the bidder who has the highest valuation. Assuming that the bid goes up continuously, she will win the object at a price equal to the *second highest valuation* (due to open ascending bid in an English auction). An English auction is equivalent to a *second-price sealed-bid auction*.

Vickrey (1996 Nobel prize winner in Economics) shows that the weakly dominant strategy in a second-price sealed-bid auction is $b_i = v_i$, thus promoting truthful bidding. That is, in an English auction with random valuations V_1, \dots, V_N with v_i known to player i , then player i 's optimal bid is v_i . The analysis is distribution free since we do not need to specify the distribution functions of the random valuations of the bidders.

Let $b_{\max} = \max_{k \neq i} b_k$, the maximum of bids other than player i 's own bid b_i . Player i wins the auction if $b_i > b_{\max}$ and payoff upon winning is $v_i - b_{\max}$. Zero payoff upon losing.

(i) $b_i > v_i$ (aggressive, payoff becomes negative when $v_i < b_{\max} < b_i$)

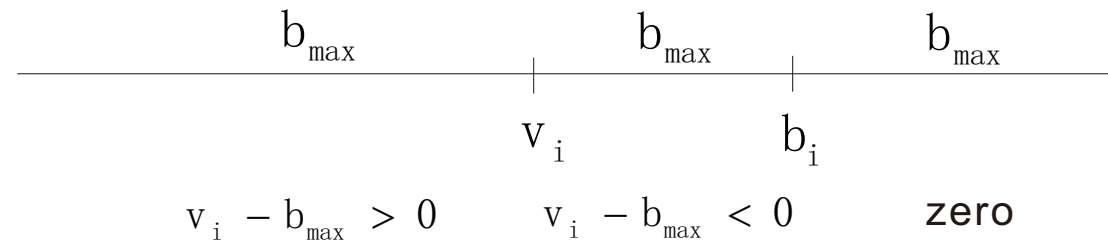

Since negative payoff may be resulted, why not choose to be less aggressive and move b_i lower down to v_i ?

(ii) $b_i < v_i$ (conservative, payoff becomes zero when $b_i < b_{\max}$ due to losing of the auction)

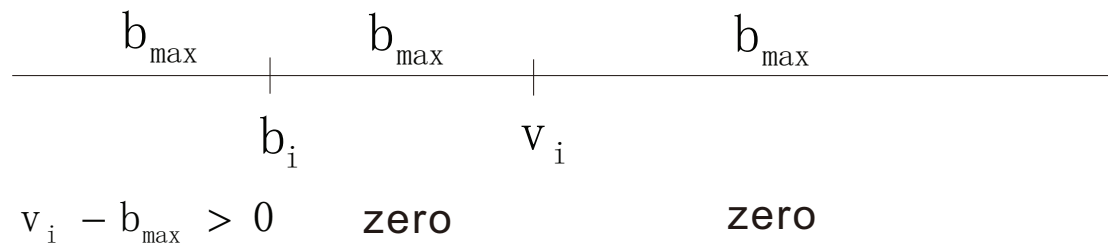

Why not enlarge the region of positive payoff by increasing b_i up to v_i ?

(iii) $b_i = v_i$

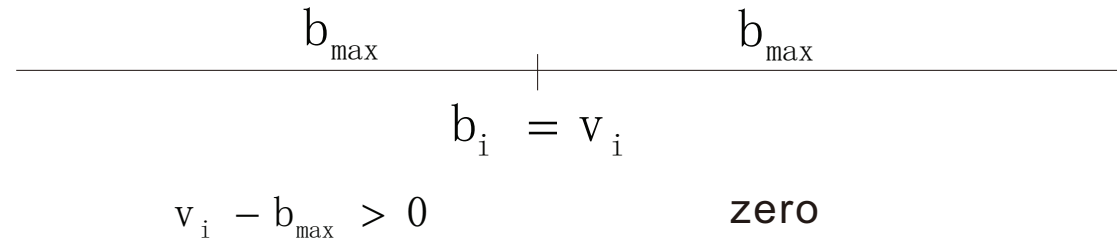

Under the two scenarios: (a) $v_i \geq b_{\max}$, (b) $v_i < b_{\max}$, we observe that the choice of $b_i = v_i$ by player i weakly dominates the other two strategies: $b_i < v_i$ and $b_i > v_i$. The weakly dominant strategy is setting truthful bid.

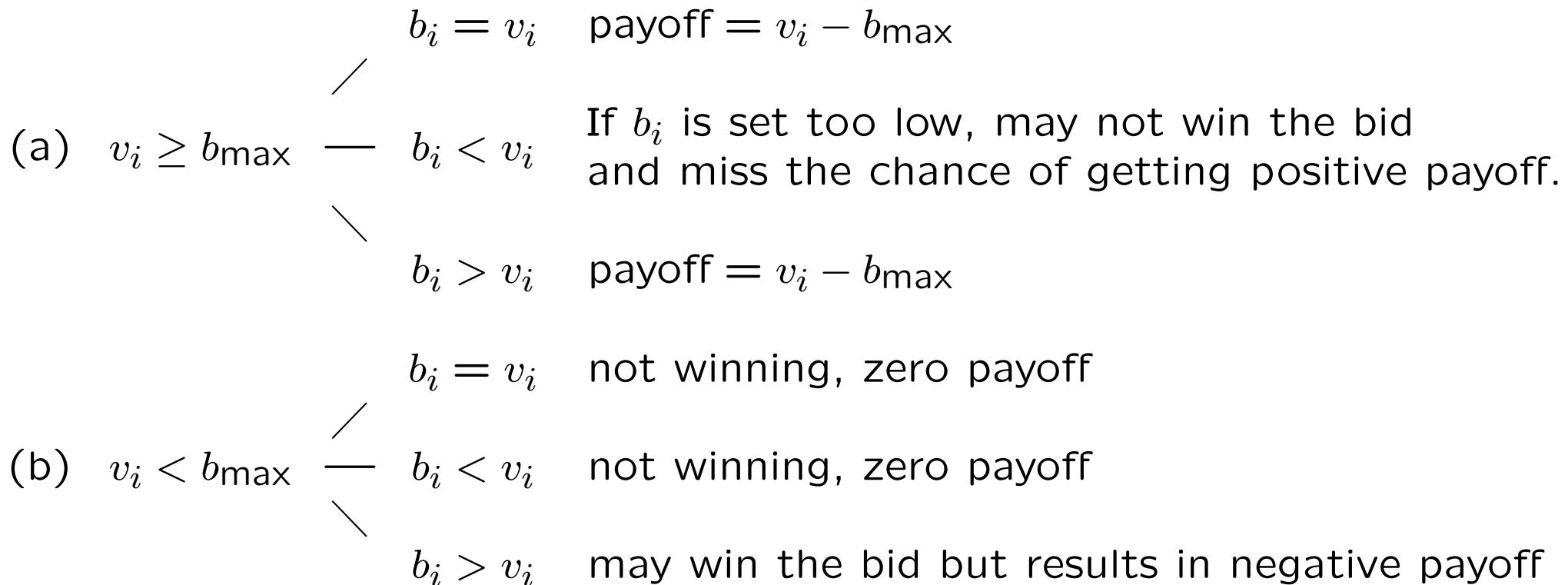

Finding the density function of $\max_2(V_1, \dots, V_N)$

Let X_1, X_2, \dots, X_n be a collection of n independent and identically distributed random variables with common density function $f(x)$ and common distribution function $F(x)$.

Define $X_{(k)}$ be the k^{th} smallest of X_i ; that is, $X_{(n-1)}$ is the second largest among X_1, X_2, \dots, X_n .

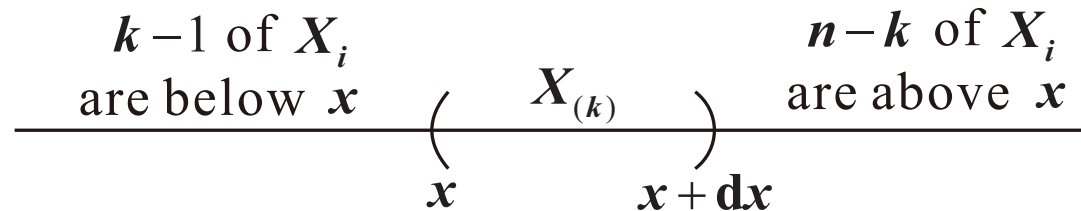

Suppose $X_{(k)} \in (x, x + dx)$, then $k - 1$ of X_i are less than or equal to x and $n - k$ are greater than x . Since all X 's are independent and identically distributed, the density function of $X_{(k)}$ is given by

$$\begin{aligned}
f_{X_{(k)}}(x) \, dx &= \sum P[V_j \leq x, j = 1, \dots, k-1] P[V_l > x, l = 1, \dots, n-k] \\
&\quad P[X_{(k)} \in (x, x + dx)] \\
&= \binom{n}{k-1, n-k, 1} [F(x)]^{k-1} [1 - F(x)]^{n-k} f(x) \, dx,
\end{aligned}$$

where $\binom{n}{k-1, n-k, 1} = \frac{n!}{(n-k)!(k-1)!}$ is the number of ways of separating a group of n objects into 3 groups of $n-k$ objects, $k-1$ objects and one object.

Assuming uniform distribution on $[0, 1]$, the common $f(x)$ and $F(x)$ are 1 and x , respectively, $0 < x < 1$. We then have

$$f_{X_{(k)}}(x) = \frac{n!}{(n-k)!(k-1)!} x^{k-1} (1-x)^{n-k}, \quad 0 < x < 1.$$

In particular, for $k = n-1$, we have

$$\begin{aligned}
f_{X_{(n-1)}}(x) &= \frac{n!}{(n-2)!} x^{n-2} (1-x) \\
&= n(n-1)x^{n-2}(1-x), \quad 0 < x < 1.
\end{aligned}$$

Expected revenue received by the seller

The winner of the English auction with uniform valuations makes the payment of the second highest bid. The expected value of the revenue received by the seller is

$$E[\max_2(V_1, \dots, V_N)] = \frac{N-1}{N+1}.$$

This follows from knowing the density of the random variable $Y = \max_2(V_1, \dots, V_N)$, the second highest valuation. When V is uniform on $[0, 1]$, the density of Y is

$$f_Y(x) = N(N-1)x^{N-2}(1-x), \quad 0 < x < 1.$$

The expected revenue is given by

$$\begin{aligned} \int_0^1 x f_Y(x) dx &= \int_0^1 N(N-1)x^{N-1}(1-x) dx \\ &= \frac{N(N-1)(N-1)!}{(N+1)!} = \frac{N-1}{N+1}. \end{aligned}$$

Difference in variance of the expected revenue received by the seller for the English and Dutch auctions

1. In an English auction, the selling price random variable is the second highest valuation, that we write as $P_E = \max_2\{V_1, \dots, V_N\}$. The corresponding order statistic is given by

$$\begin{aligned}\text{var}(P_E) &= E[X_{(n-1)}^2] - E[X_{(n-1)}]^2 \\ &= \int_0^1 N(N-1)x^N(1-x) dx - \left(\frac{N-1}{N+1}\right)^2 \\ &= \frac{N(N-1)}{(N+2)(N+1)} - \left(\frac{N-1}{N+1}\right)^2 \\ &= \frac{2(N-1)}{(N+1)^2(N+2)}.\end{aligned}$$

Remark

$$\int_0^1 x^m(1-x)^n dx = \frac{m!n!}{(m+n+1)!}.$$

2. In a Dutch auction, equivalent to a first-price sealed-bid auction, the selling price is $P_D = \beta(\max\{V_1, \dots, V_N\})$. We have seen that with uniform valuations

$$\beta(\max\{V_1, \dots, V_N\}) = \frac{N-1}{N} \max\{V_1, \dots, V_N\}.$$

Recall that the density function $f_Y(x)$ of $\max\{V_1, \dots, V_N\}$ is Nx^{N-1} . Consequently,

$$\begin{aligned} \text{var}(P_D) &= \text{var}(\beta(\max\{V_1, \dots, V_N\})) \\ &= \left(\frac{N-1}{N}\right)^2 \text{var}(\max\{V_1, \dots, V_N\}) \\ &= \left(\frac{N-1}{N}\right)^2 \left[\int_0^1 x^2 f_Y(x) dx - \left(\int_0^1 x f_Y(x) dx \right)^2 \right] \\ &= \left(\frac{N-1}{N}\right)^2 \left[\int_0^1 Nx^{N+1} dx - \left(\int_0^1 Nx^N dx \right)^2 \right] \\ &= \frac{(N-1)^2}{N(N+1)^2(N+2)}. \end{aligned}$$

We claim that $\text{var}(P_D) < \text{var}(P_E)$. That will be true if

$$\frac{2(N-1)}{(N+1)^2(N+2)} > \frac{(N-1)^2}{N(N+1)^2(N+2)}.$$

This inequality reduces to the condition $2 > \frac{N-1}{N}$, which is absolutely true for any $N \geq 1$.

Dutch auctions are less risky for the seller than are English auctions, as measured by the variance of the revenue. Recall that

$$\beta_D(v) = \frac{N-1}{N}v \quad \text{and} \quad \beta_E(v) = v.$$

The payoff of an English auction depends on both the first prize and second prize. Intuitively, we expect a larger dispersion of $\max_2(V_1, V_2, \dots, V_N)$ when compared with $\max(V_1, V_2, \dots, V_N)$.

Note that the expected revenues of the two types of auctions are the same under uniform distributions. We shall show a much stronger result: the expected revenues of all auctions are the same under any probability distribution of valuation. This is the revenue equivalence theorem.

Linear bidding rules for two-bidder Dutch auction game

We consider the two-bidder Dutch auction game when the valuations are uniformly distributed in the interval $[r, R]$, where r is the reserve price. We would like to show that the linear bidding rules

$$\beta_1^*(v_1) = \frac{r + v_1}{2} \text{ and } \beta_2^*(v_2) = \frac{r + v_2}{2}$$

constitute a Nash equilibrium. That is, $\beta_1^*(v_1)$ is a best response to $\beta_2^*(v_2)$, and vice versa.

The independent valuations of the players are the random variables V_1 and V_2 with identical cumulative distribution function $F_V(v)$.

We consider two bidders whose payoff functions are given by:

$$U_1((b_1, v_1), (b_2, v_2)) = \begin{cases} v_1 - b_1, & \text{if } b_1 > b_2; \\ 0, & \text{if } b_1 < b_2; \end{cases}$$
$$U_2((b_1, v_1), (b_2, v_2)) = \begin{cases} v_2 - b_2, & \text{if } b_2 > b_1; \\ 0, & \text{if } b_2 < b_1. \end{cases}$$

At $b_1 = b_2$, we need to specify the tie breaking rule that determines the payoffs to the two bidders.

Each bidder knows his or her own valuation but not that of the opponent. The expected payoff to bidder 1 is

$$u_1(b_1, b_2) = E[U_1(b_1, v_1, b_2(V_2), V_2)] = P[b_1 > b_2(V_2)](v_1 - b_1).$$

The payoff is zero when bidder 1 loses. We observe that the probability of tie: $P[b_1 = b_2(V_2)]$ has zero measure since V_2 is a continuous random variable.

To establish Nash equilibrium, we would like to show that β_1^* is the best response of player 1 when player 2 chooses β_2^* . Note that $F(v) = \frac{v-r}{R-r}$, which observes $F(r) = 0$, $F(R) = 1$ and $F(v)$ is linear in v . By the linear bidding rule, where $\beta_2^*(V_2) = \frac{r+V_2}{2}$, we have

$$\begin{aligned} P[b_1 > \beta_2^*(V_2)] &= P[b_1 > \frac{r + V_2}{2}] = P[2b_1 - r > V_2] \\ &= F(2b_1 - r) = \frac{(2b_1 - r) - r}{R - r}, \end{aligned}$$

provided that $r < 2b_1 - r < R \Leftrightarrow r < b_1 < \frac{r+R}{2}$ (which is valid).

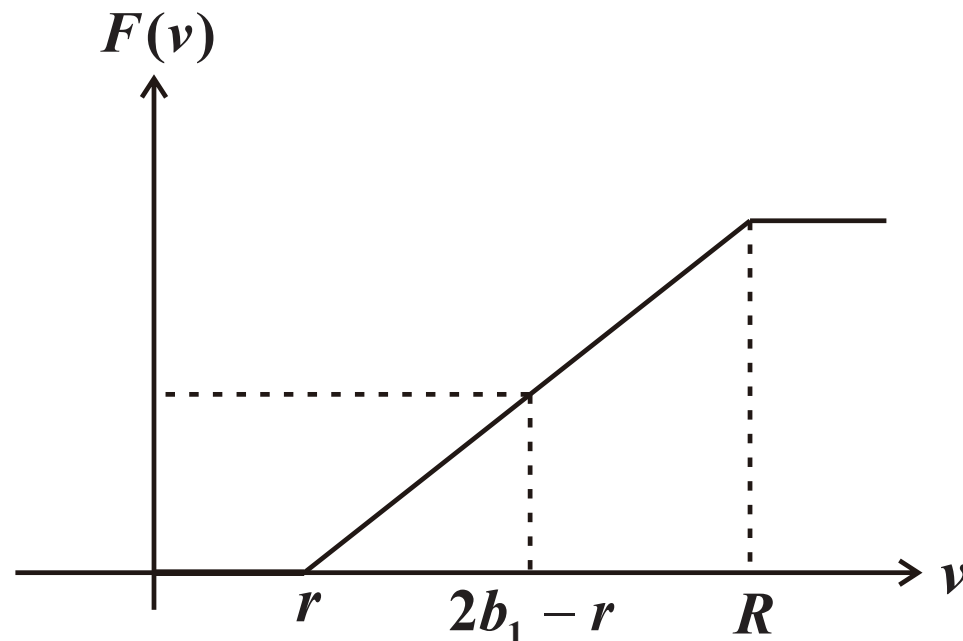

Recall that V_2 lies within $[r, R]$ so that $b_2 = \beta_2^*(V_2) = \frac{r + V_2}{2}$ lies within $\left[r, \frac{r + R}{2}\right]$. Bidder 1 is sure to lose if $b_1 < r$ and sure to win if $b_1 > \frac{r + R}{2}$. When player 2 plays the linear bidding rule (Nash strategy), then the expected payoff to player 1 is

$$\begin{aligned}
 u_1(b_1, \beta_2^*(V_2)) &= (v_1 - b_1)P[b_1 > \beta_2^*(V_2)] \\
 &= (v_1 - b_1)P[V_2 < 2b_1 - r] \\
 &= \begin{cases} 0, & \text{if } b_1 < r; \\ (v_1 - b_1)\frac{2b_1 - 2r}{R - r}, & \text{if } r \leq b_1 \leq \frac{r + R}{2}; \\ v_1 - b_1 & \text{if } \frac{r + R}{2} < b_1. \end{cases}
 \end{aligned}$$

Both the conservative strategy ($b_1 < r$) and aggressive strategy ($b_1 > \frac{r + R}{2}$) are dominated.

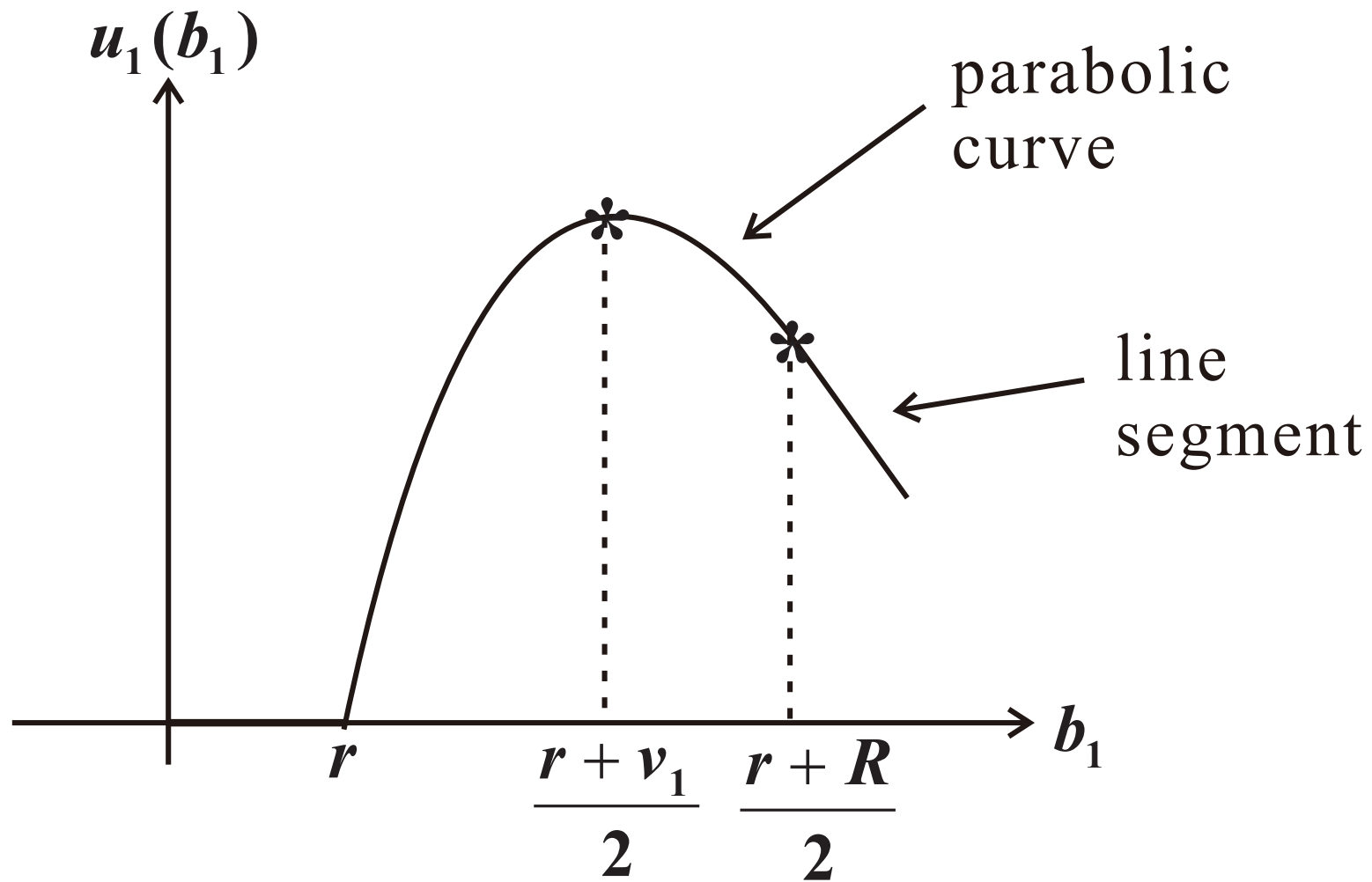

We want to maximize $u_1(b_1, \beta_2^*(V_2))$ as a function of b_1 . We define

$$g(b_1) = (v_1 - b_1) \frac{2b_1 - 2r}{R - r}.$$

The function g is strictly concave downward as a function of b_1 and has a unique maximum at $b_1 = \frac{r+v_1}{2}$. We conclude that

$$\beta_1^*(v_1) = \frac{r + v_1}{2}$$

maximizes $u_1(b_1, \beta_2^*)$ for $b_1 \leq \frac{r + R}{2}$.

For the last case where $b_1 > \frac{r + R}{2}$, bidder 1 is sure to win. However, it is straightforward to deduce that

$$u_1(\beta_1^*, \beta_2^*) > u_1(b_1, \beta_2^*) \text{ for } b_1 > \frac{r + R}{2}.$$

This is because

$$u_1(\beta_1^*, \beta_2^*) > u_1\left(\frac{r+R}{2}, \beta_2^*\right)$$

and $u_1(b_1, \beta_2^*)$ is decreasing in b_1 for $b_1 \geq \frac{r+R}{2}$.

Combining these results, we conclude that the linear bidding rule $\beta_1^*(v_1)$ is a best response to the bidding rule $\beta_2^*(v_2)$.

Remark

The optimal bid for the two-player ($N = 2$) Dutch auction is

$$\left(1 - \frac{1}{2}\right)v = \frac{v}{2}$$

for uniform distribution over $[0, 1]$. This result is consistent with the linear bidding rule.

Numerical example $[r, R] = [750, 1000]$

first-prize sealed-bid (Dutch)	second-prize sealed-bid (English)
$\beta_{\text{Dutch}}(v_i) = \frac{r+v_i}{2}, i = 1, 2$	$\beta_{\text{Eng}}(v_i) = v_i, i = 1, 2$
$v_1 = 800, b_1 = 775$	(i) $v_1 = 800, b_1 = 800$
$v_2 = 850, b_2 = 800$	$v_2 = 850, b_2 = 850$
$U_2 = v_2 - b_2 = 850 - 800 = 50$	$U_2 = v_2 - b_1 = 850 - 800 = 50$
	(ii) $v_1 = 775, b_1 = 775$
	$v_2 = 850, b_2 = 850$
	$U_2 = v_2 - b_1 = 850 - 775 = 75$
	Lucky for bidder 2, she gains more when v_1 is lowered.

Recall that the expected revenue to the seller of the item remains the same under any auction rules.

Expected payment made by a bidder

The random valuations (private values) of the object are independently drawn from the common cumulative distribution function $F(v)$ on $[v_{\min}, v_{\max}]$. We assume $\beta(x)$ to be the optimal bidding function common to all bidders.

Unlike the previous discussion where we derive the governing equation, we take $\beta(x)$ to be given. We express the bidder 1's bid as $b_1 = \beta(x)$. The bidding function varies with respect to different auction rules. The optimal bidder 1's bid b_1^* occurs at $\beta(x)$ evaluated at $x = v_1$, $b_1^* = \beta(v_1)$, where v_1 is the player 1's personal valuation known to himself.

Note that bidder 1 is the winner if $\beta(x)$ is the largest among $\beta(v_2), \dots, \beta(v_N)$. Since β is strictly increasing, so bidder 1 is the winner if all other valuations are less than x . The probability of winning is $P[V_i < x]^{N-1} = F^{N-1}(x)$, so the bidder 1's expected payoff is

$$\Pi(x; v_1) = v_1 F^{N-1}(x) - D(x),$$

where $D(x)$ is the *expected payment* made by bidder 1.

Here, x is the dummy variable in the optimal bidding function. As $\beta(x)$ is monotonically increasing, there is a one-to-one correspondence between x and $b_1 = \beta(x)$ via the optimal bidding function β . With the use of x instead of b_1 , the probability of winning can be expressed conveniently as $F^{N-1}(x)$ instead of $F^{N-1}(\beta^{-1}(b_1))$. We consider the variation of the bid $b_1 = \beta(x)$ corresponding to varying values of x , which affects the probability of winning and expected payment. We should not set $x = v_1$ at this point yet. In the later step, we put $x = v_1$ in the first order condition at the optimal bid, where $b_1 = b_1^* = \beta(v_1)$.

Based on assumption of symmetric bidders, all other $N - 1$ bidders play the bids $\beta(v_2), \dots, \beta(v_N)$ using the same optimal bidding function. The resulting optimization of $\Pi(x; v_1)$ is a Nash equilibrium bidding function as all other bidders play their parts of Nash equilibrium.

We determine $D(x)$ in terms of $F(x)$ such that $\Pi(x; v_1)$ is maximized at $x = v_1$. We now drop subscript “1” in v_1 for notational convenience.

Necessary condition for optimality

The choice variable for bidder 1 is b_1 . At the optimal bid $b_1^* = \beta(v)$, by the first order condition, the derivative of $\Pi(x; v)$ with respect to b_1 evaluated at $b_1^* = \beta(v)$ is zero. Treating $x = \beta^{-1}(b_1)$, where β^{-1} is the inverse function of β , we have $x = v$ when $b_1 = b_1^*$.

Applying the chain rule of differentiation, we obtain

$$\frac{dF^{N-1}(x)}{db_1} \Big|_{b_1^* = \beta(v)} = \frac{dF^{N-1}(x)}{dx} \Big|_{x=v} \frac{dx}{db_1} \Big|_{b_1^* = \beta(v)}$$

and a similar result for the term $D(x)$. After canceling the common factor $\frac{dx}{db_1} \Big|_{b_1^* = \beta(v)}$ [which is nonzero since $\beta(x)$ is monotonic in x], the first order condition evaluated at $b_1^* = \beta(v)$ or $x = \beta^{-1}(b_1^*) = v$ gives

$$v \frac{dF^{N-1}(v)}{dv} = \frac{d}{dv} D(v).$$

The goal is to find $D(v)$, which is seen to be dependent on $F(v)$ only.

Given the known distribution function $F(v)$, one can integrate with respect to v to obtain $D(v)$. Note that

$$\int v \frac{dF^{N-1}(v)}{dv} = vF^{N-1}(v) - \int F^{N-1}(u) du.$$

By performing integration by parts from v_{\min} to v , we obtain

$$D(v) - D(v_{\min}) = vF^{N-1}(v) - v_{\min}F^{N-1}(v_{\min}) - \int_{v_{\min}}^v F^{N-1}(u) du.$$

The bidder whose personal valuation assumes the lowest value v_{\min} should have zero expected profit since the chance of winning is zero. Observing

$$\Pi(x; v_{\min})|_{x=v_{\min}} = v_{\min}F^{N-1}(v_{\min}) - D(v_{\min}) = 0,$$

we obtain

$$D(v) = vF^{N-1}(v) - \int_{v_{\min}}^v F^{N-1}(u) du.$$

The expected payment $D(v)$ made by bidder 1 depends on $F(v)$ only, and independent of the auction rule.

First-prize auction

Note that the different auction rules give rise to different relations between D and β , the expected payment $D(v)$ made by bidder 1 in the first-prize auction is the probability of winning multiplying the value of bid $= F^{N-1}(v)\beta(v)$. This relation provides an easy procedure to determine $\beta(v)$.

Dividing $D(v) = F^{N-1}(v)\beta(v)$ by $F^{N-1}(v)$, the optimal bidding function is found to be

$$\beta(v) = v - \frac{\int_{v_{\min}}^v F^{N-1}(u) \, du}{F^{N-1}(v)}.$$

As a verification, suppose we take $F(v) = v$ and $v_{\min} = 0$, we obtain the earlier result of the Dutch auction with uniform valuation over $[0, 1]$ as follows

$$\beta(v) = v - \frac{\int_0^v u^{N-1} \, du}{v^{N-1}} = v - \frac{1}{N}v = \left(1 - \frac{1}{N}\right)v.$$

Charity (all-pay) auction

For the charity (all-pay) auction, we have $D(v) = \beta(v)$ since the payment by the bidder is independent of winning or otherwise. We then obtain

$$\beta_{\text{charity}}(v) = vF^{N-1}(v) - \int_{v_{\min}}^v F^{N-1}(u) \, du.$$

Note that when $v = v_{\min}$, we have

$$\beta_{\text{charity}}(v_{\min}) = v_{\min}F^{N-1}(v_{\min}) = 0$$

since $F(v_{\min}) = 0$. This is expected since bidders in an all-pay auction would set zero bid when $v = v_{\min}$ as the probability of winning is zero.

When we take $F(v) = v$ on $[0, 1]$ (uniform distribution on $[0, 1]$), we have

$$\beta_{\text{charity}}(v) = v^N - \int_0^v u^{N-1} \, du = v^N - \frac{v^N}{N} = \left(1 - \frac{1}{N}\right) v^N.$$

Note that $\left(1 - \frac{1}{N}\right) v^N = \beta_{\text{charity}}(v) \leq \beta_{\text{Dutch}}(v) = \left(1 - \frac{1}{N}\right) v$.

Seller's expected revenue received from one bidder

Recall that the bidder's payment is zero when he loses and equals $\beta(v)$ under the first auction rule when he wins, $D(v)$ is the *expected payment* made by bidder 1 when her personal valuation of the object is v . It is necessary to integrate $D(v)$ with respect to the density function of V to give the seller's expected revenue received from bidder 1, where

$$\begin{aligned} \int_{v_{\min}}^{v_{\max}} D(v) \, dF(v) &= \int_{v_{\min}}^{v_{\max}} vF^{N-1}(v) \, dF(v) - \int_{v_{\min}}^{v_{\max}} \left(\int_{v_{\min}}^v F^{N-1}(u) \, du \right) \, dF(v) \\ &= \int_{v_{\min}}^{v_{\max}} vF^{N-1}(v)F'(v) \, dv - \int_{v_{\min}}^{v_{\max}} \left(\int_u^{v_{\max}} F'(v) \, dv \right) F^{N-1}(u) \, du \\ &= \int_{v_{\min}}^{v_{\max}} [uF'(u) + F(u) - 1]F^{N-1}(u) \, du, \end{aligned}$$

by noting that $\int_u^{v_{\max}} F'(v) \, dv = F(v_{\max}) - F(u) = 1 - F(u)$.

Interestingly, the seller's expected revenue from bidder 1 is dependent on $F(v)$ but independent of the optimal bidding function $\beta(v)$. Hence, we establish the revenue equivalence result.

Revenue equivalence theorem

Any symmetric private value auction with identically distributed valuations, satisfying the following conditions, always has the same expected revenue to the seller of the object:

For example, when $F(v) = v$ on $[0, 1]$, $vF'(v) = v$. The total expected revenue received by the seller for any auction from all N bidders is given by

$$N \int_0^1 (2v - 1)v^{N-1} \, dv = N \left(\frac{2}{N+1} - \frac{1}{N} \right) = \frac{N-1}{N+1}.$$

This result holds for the charity auction as well. Since all bidders pay, the corresponding total expected revenue received from all N bidders is

$$N \int_0^1 \beta_{\text{charity}}(v) \, dv = N \int_0^1 \frac{N-1}{N} v^N \, dv = \frac{N-1}{N+1}.$$

Technical step in the transformation of the definite double integral

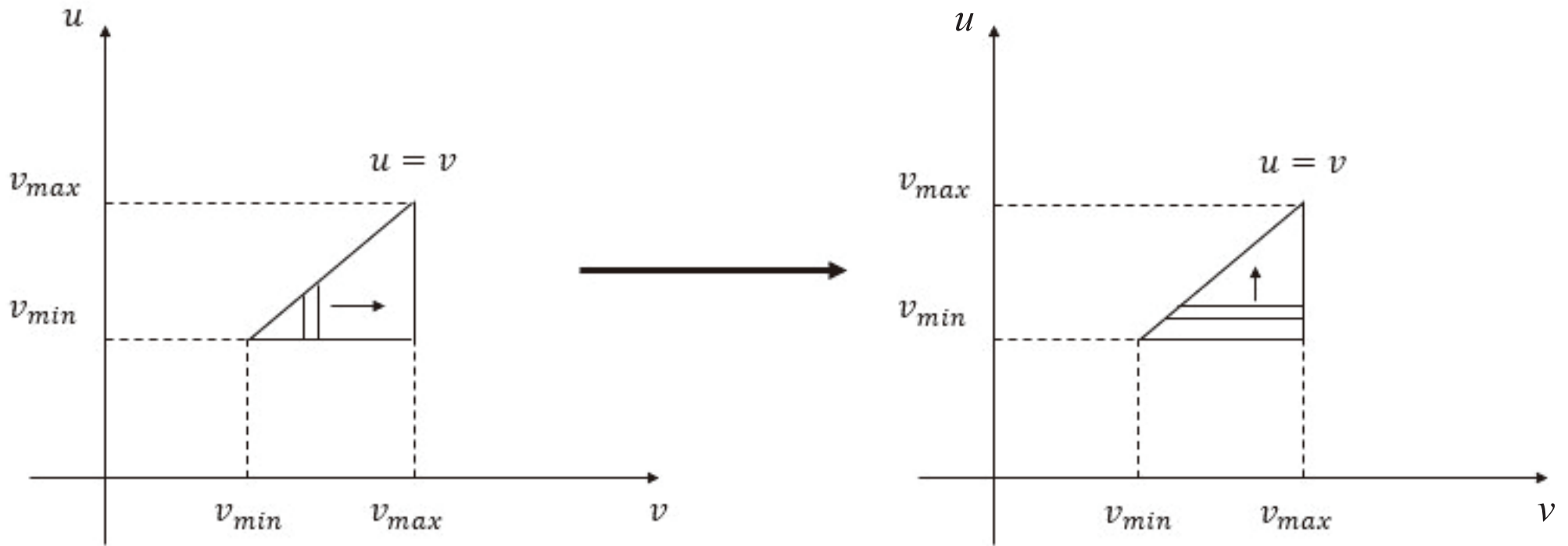

$$\int_{v_{\min}}^{v_{\max}} \int_{v_{\min}}^v F^{N-1}(u) \, du \, F'(v) \, dv = \int_{v_{\min}}^{v_{\max}} \int_u^{v_{\max}} F'(v) \, dv \, F^{N-1}(u) \, du$$

$$= \int_{v_{\min}}^{v_{\max}} [1 - F(u)] F^{N-1}(u) \, du$$

3.4 Duel games

Nature and optimal timing

One party insults the honor of another. The two parties face each other down with pistols, and take alternating steps toward one another. They must decide when to shoot. Victory means life and honor restored; loss means death and dishonor.

“Pistols at 10 paces” and other forms of dueling were once commonplace in Europe and the early United States.

- Alexander Hamilton, who graces \$10 Federal Reserve notes, died in a duel in 1804. The counterparty is Aaron Burr, then Vice President of the United States. Of course, duels are no longer as common a dispute-resolution mechanism as they used to be.

Strategic decision: When to shoot?

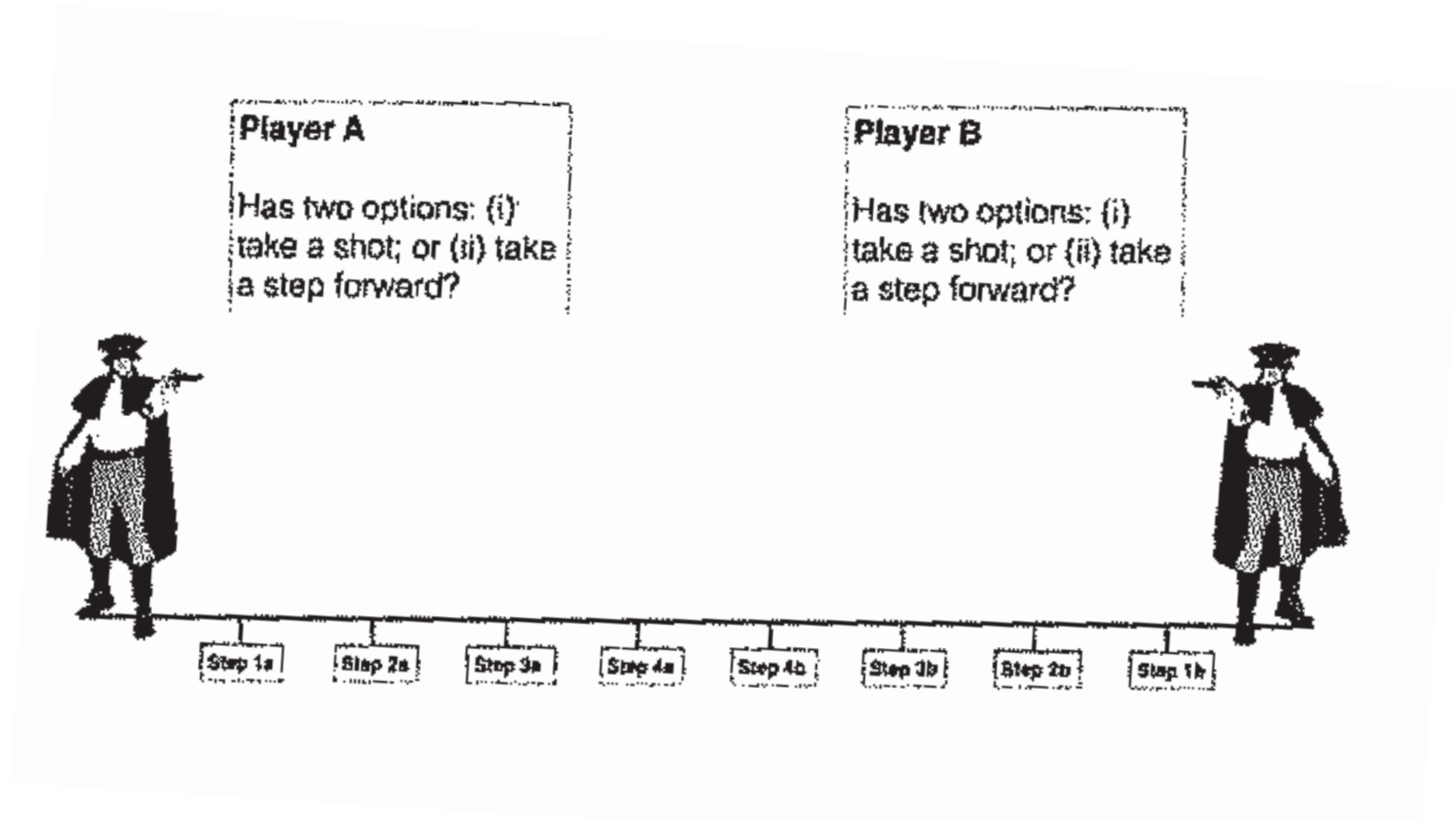

Should you shoot at a given distance apart? Or should you wait until the next round of your turn of shooting? The best strategy depends on the accuracy functions of the two duelists.

Rules of the duel

- The players have alternative turns. In each turn, the player can shoot or take a step forward.
- There is only one bullet. The opponent knows whether the bullet has been fired (noisy duel).
- If she shoots and hits, then she wins. If she misses, then the game continues, so effectively she loses. The other player can wait until they are zero distance apart and shoots.

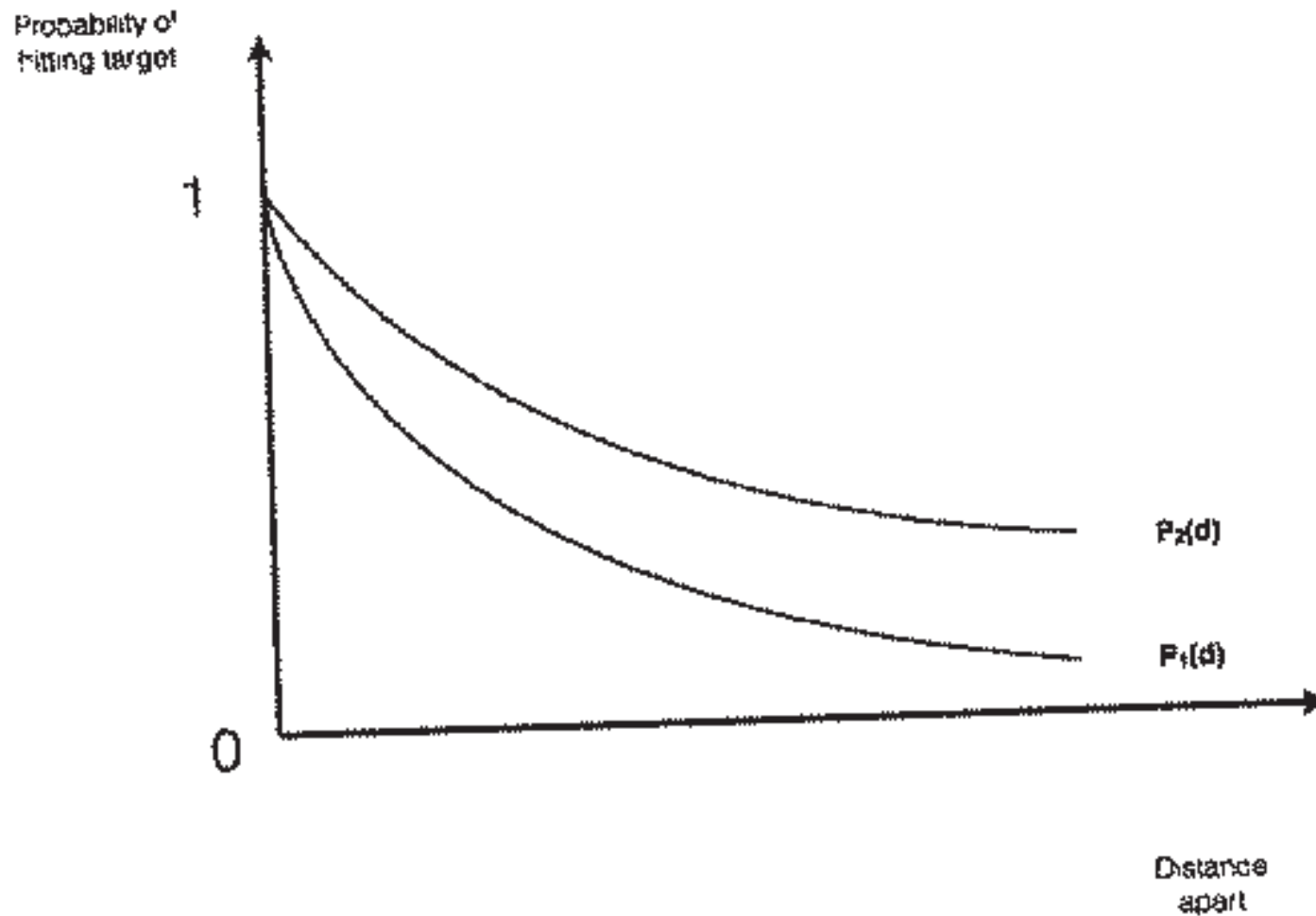

The players' probabilities of hitting (accuracy functions) are known to both players. The challenge is the empirical calibration of the accuracy functions.

Properties of the accuracy functions

1. $P_1(d)$ and $P_2(d)$ are both decreasing functions of d . It is not necessary to have $P_1(d) > P_2(d)$ for all values of d .
2. $P_1(0) = P_2(0) = 1$. That is, sure to hit when fire from point-blank range.

Speculations

1. Should a better shot shoot first since she has a better chance of hitting the opponent?
2. Should a worse shot try to preempt the better shot?

Related problem: When to launch a product if you know that only one product will survive. A rival is also developing a product. If you launch a product too early, and if it fails, your wealth would be ruined. One may choose to wait until the chance of success is higher.

Three-person shooting game under sequential shooting rule

Each of the three persons A , B , and C has a gun containing a single bullet. Each person, as long as she is alive, may shoot at any surviving person.

Rule of the game: First, A shoots, then B (if still alive), then C (if still alive).

Denote by p_i the probability that player i hits her intended target; assume that $0 < p_i < 1$. Assume that each player wishes to maximize her probability of survival. Among outcomes in which her survival probability is the same, she wants to minimize the survival probabilities of others.

Assuming that p_A , p_B and p_C are all different, it is interesting to observe that “weakness is strength” for C : she is better off if $p_C < p_B$ than if $p_C > p_B$.

- B is more likely to be chosen by A to be the more preferable target when B has higher accuracy function than that of C . The better strategy is to kill the more skillful shooter.
- Suppose C survives, C would choose to shoot even his survival probability would not be affected (since A and B have shot or died). This act is to minimize the survival probabilities of others, though C ' own survival probability is 100% already.

Extension: Add the fourth Player L , who is the first one to shoot. Once we know the dominant strategy of A . We simply go one step backward to examine L 's strategy.

Backward induction and dominance

- We start from C , the strategy of the last shooter, based on the principle of *backward induction*. In analyzing multi-round games, we look first to the last possible move in the game and work backward.
- If C chooses to shoot B (A), then A (B) always survives. Shooting either one is just minimizing the survival probability of either one of the surviving opponents.
- By *dominance*, B always shoots C since C poses a threat to B while A has already shot.

Suppose C is alive when it is B 's turn to shoot, B will shoot C .
 Suppose C is dead when it is B 's turn to shoot, B will shoot A .

(i) A shoots B

Given the above analysis, if A shoots B , the death probability of A is

$$\underbrace{P_A P_C}_{\text{kill } B \& A} + 0.5 \underbrace{(1 - P_A)}_{A \text{ misses } B} \underbrace{(1 - P_B)}_{B \text{ misses } C} \underbrace{P_C}_{C \text{ kills } A} .$$

The first term corresponds to A kills B and C kills A . The last term corresponds to the scenario where C kills A conditional on both A and B miss the shot. Under this scenario, we assume 50% chance that C chooses to shoot A .

(ii) A shoots C

If A shoots C , the death probability of A is

$$\underbrace{P_A P_B}_{\text{kill } C \& A} + 0.5 \underbrace{(1 - P_A)}_{A \text{ misses } C} \underbrace{(1 - P_B)}_{B \text{ misses } C} \underbrace{P_C}_{C \text{ kills } A} .$$

If $P_C < P_B$, then B is more likely to be chosen by A as the more preferable target since shooting B lowers the death probability of A .

Continuous duel game models

Under the continuous duel assumption, the duelists do not take finite steps and shoot in turn. They move in infinitesimally small steps and can shoot at any distance.

Each player wishes to delay his decision as long as possible, but he may be penalized for waiting. In a duel, each duelist wishes to hold his fire as long as possible, since his accuracy increases with shorter distance. However, if the duelist holds his fire too long, his opponent may have a higher chance to win the duel.

If a duelist is informed about his opponent's actions as soon as they take place, we shall call the duel a *noisy duel*. If neither duelist ever learns when or whether his opponent has fired, we shall call the duel a *silent duel*.

Noisy duels: One bullet for each duelist

Assume that if a duelist fires and misses, the other duelist can obtain a sure hit by waiting until they are together. The duelists, starting at a distance D apart, approach each other with no opportunity for retreat. The accuracies increase steadily as the duelists approach each other and ultimately are certainty, or 1, when the duelists are at zero distance apart.

A strategy for Blue (player 1) is to fire his bullet when the duelists are x units apart, where $0 \leq x \leq D$. Similarly, a strategy for Red (player 2) is to fire her bullet when the duelists are y units apart, where $0 \leq y \leq D$.

Let the payoff be 1 to the surviving duelist and -1 to the non-surviving duelist. The payoff $M(x, y)$, to Blue, is his expectation of survival for his three possible ranges of firing times: firing before Red fires ($x > y$), firing at the same time as Red fires ($x = y$), and firing after Red fires ($x < y$).

Recall that if the first shot misses, then the opponent is sure to win. If both fire at the same time and miss or hit, then the payoff is zero. When $x = y$, the contribution to the expected payoff is zero if both hit or miss. The expected payoff to Blue is given by

$$M(x, y) = \begin{cases} P_1(x)(1) + [1 - P_1(x)](-1) = 2P_1(x) - 1 & \text{if } x > y \\ P_1(x)[1 - P_2(x)](1) + P_2(x)[1 - P_1(x)](-1) \\ \quad = P_1(x) - P_2(x) & \text{if } x = y \\ P_2(y)(-1) + [1 - P_2(y)](1) = 1 - 2P_2(y) & \text{if } y > x. \end{cases}$$

For Red, under this zero sum game, she chooses y and firing strategies so as to minimize the payoff $M(x, y)$ to Blue.

For Blue, he chooses x to maximize $M(x, y)$, taking into account $\min_y M(x, y)$. This is the so-called max-min strategy.

Only the last case, $y > x$, where $M(x, y)$ has dependence on y . Since $P_2(y)$ is a decreasing function of y , so Red chooses y to be x^+ for $y > x$ in order to minimize $M(x, y)$. That is, Red shoots right before Blue does. Note that $1 - 2P_2(y)$ is minimized by choosing $y = x^+$.

It follows that

$$\max_x \min_y M(x, y) = \max_x \min[2P_1(x) - 1, P_1(x) - P_2(x), 1 - 2P_2(x)].$$

Though the 3 functions are now independent of y , Red can still choose among the three strategies, (i) firing earlier, (ii) firing simultaneously, (iii) firing later, to achieve the minimum among the 3 functions.

Let $\mu(x) = \min[2P_1(x) - 1, P_1(x) - P_2(x), 1 - 2P_2(x)]$.

We divide the interval $[0, D]$ into three intervals as follows:

<i>Interval</i>	<i>Consists of those x for which</i>
A	$P_1(x) + P_2(x) \geq 1$
B	$P_1(x) + P_2(x) = 1$
C	$P_1(x) + P_2(x) \leq 1$

Since both $P_1(x)$ and $P_2(x)$ are monotonically decreasing functions in x , with $P_1(0) + P_2(0) = 2$ and $P_1(D) + P_2(D) \approx 0$, so there exists an unique x^* such that $P_1(x^*) + P_2(x^*) = 1$ where $x^* \in [0, D]$.

Note that there is single point x^* in B , and the intervals A and C intersect at the single point represented by B .

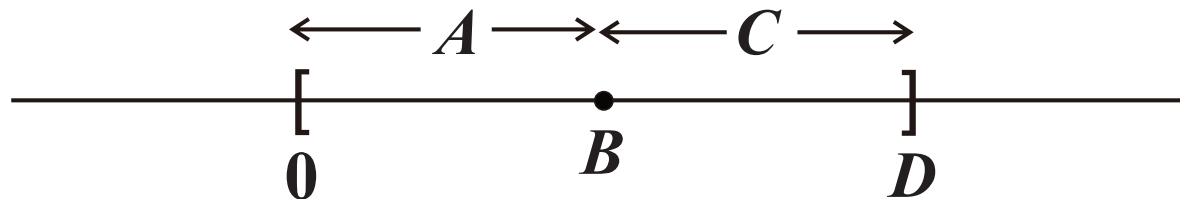

To find $\max_x \mu(x)$, we first find $\max_{x \in A} \mu(x)$, $\max_{x \in B} \mu(x)$ and $\max_{x \in C} \mu(x)$, then find the maximum among these three quantities.

$$\max_x \min_y M(x, y) = \max_x \mu(x) = \max[\max_{x \in A} \mu(x), \max_{x \in B} \mu(x), \max_{x \in C} \mu(x)].$$

1. Note that $x \leq x^*$ for all x in A . Since $P_1(x) + P_2(x) \geq 1$, from which we can deduce the relative magnitudes of $1 - 2P_2(x)$, $P_1(x) - P_2(x)$ and $2P_1(x) - 1$. We obtain

$$1 - 2P_2(x) \leq P_1(x) - P_2(x) \leq 2P_1(x) - 1.$$

Therefore, if $x \in A$, then $\mu(x) = 1 - 2P_2(x)$. Since $P_2(x)$ is decreasing in x , so the maximum value of $1 - 2P_2(x)$ occurs at $x = x^*$.

2. In interval B , which is the point x^* , we have $P_1(x) + P_2(x) = 1$. It follows that

$$1 - 2P_2(x) = P_1(x) - P_2(x) = 2P_1(x) - 1.$$

Therefore, if $x \in B$, then

$$\max_{x \in B} \mu(x) = P_1(x^*) - P_2(x^*).$$

3. Interval C is defined by those $x \geq x^*$ for which

$$P_1(x) + P_2(x) \leq 1.$$

It follows that

$$2P_1(x) - 1 \leq P_1(x) - P_2(x) \leq 1 - 2P_2(x).$$

Therefore, for all x in C , we have

$$\mu(x) = 2P_1(x) - 1.$$

Again, the maximum value of $2P_1(x) - 1$ occurs at $x = x^*$.

It follows that

$$\begin{aligned}\max_{x \in A} \mu(x) &= 1 - 2P_2(x^*), \\ \max_{x \in B} \mu(x) &= P_1(x^*) - P_2(x^*), \\ \max_{x \in C} \mu(x) &= 2P_1(x^*) - 1.\end{aligned}$$

These three maximum values are the same since

$$P_1(x^*) + P_2(x^*) = 1.$$

Therefore, we have

$$\max_x \min_y M(x, y) = P_1(x^*) - P_2(x^*),$$

where x^* satisfies the equation

$$P_1(x^*) + P_2(x^*) = 1.$$

In a similar manner we can show that

$$\min_y \max_x M(x, y) = P_1(y^*) - P_2(y^*)$$

where y^* satisfies the equation

$$P_1(y^*) + P_2(y^*) = 1.$$

The optimal strategy for each player is to fire when he is at a distance ℓ from his opponent as given by

$$P_1(\ell) + P_2(\ell) = 1.$$

The value of the game is $P_1(\ell) - P_2(\ell)$.

Nash equilibrium strategy pair

The optimal strategy for the duelists is to fire their bullets simultaneously at a distance x^* which satisfies the equation

$$P_1(x^*) + P_2(x^*) = 1.$$

Note that

$$M(x, y^*) \leq M(x^*, y^*) = P_1(x^*) - P_2(x^*) \leq M(x^*, y)$$

for all values of x and y that lie in $[0, D]$. We observe that (x^*, y^*) is a Nash equilibrium strategy pair. One can observe

$$M(x, y^*) = \begin{cases} 2P_1(x) - 1 & \text{if } x > y^* \\ P_1(y^*) - P_2(y^*) & \text{if } x = y^* \\ 1 - 2P_2(y^*) & \text{if } x < y^* \end{cases},$$

which is less than or equal to $P_1(x^*) - P_2(x^*)$, $x^* = y^*$.

In other words, if Red chooses a strategy y other than y^* , the payoff to Blue would be at least as good as $M(x^*, y^*)$ or better (worse off for Red).

Example

Suppose that Blue's accuracy is given by $P_1(x) = 1 - x$ and Red's accuracy is given by $P_2(y) = 1 - y^2$. Then each duelist should fire his bullet at distance x determined by

$$1 - x + 1 - x^2 = 1 \Leftrightarrow x + x^2 = 1$$

or $x = 0.62$. The value of this duel is $x^2 - x = -0.24$ to Blue and $+ 0.24$ to Red.

If the two duelists have the same accuracies, then they should fire when their accuracies are 0.5. The value of this duel game is zero.

Silent duels

Opponent does not know whether a shot has been fired. Take $P_I(x) = x$, $x \in [0, 1]$ to characterize the probability function of player I playing strategy x . Applying the same definition for $P_{II}(y) = y$, $y \in [0, 1]$.

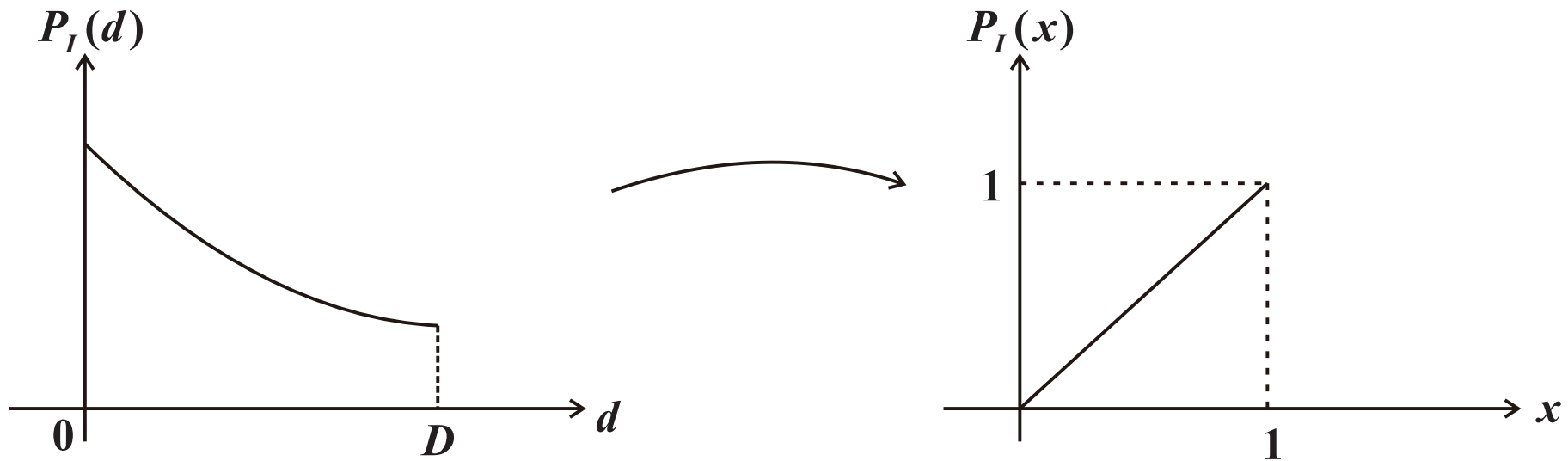

Mapping of the accuracy function $P_I(d)$ to a probability function of strategy x chosen within $[0, 1]$. The interval $[P_I^{-1}(x + dx), P_I^{-1}(x)]$ in the d -variable is mapped to $[x, x + dx]$ in the x -variable. Choosing a strategy at a smaller value of x means firing at a longer distance (firing earlier).

We consider the symmetric case where $P_I(d)$ and $P_{II}(d)$ are equal; that is, the two players have the same accuracy function.

When I fires first, $x < y$, the probability of I being killed by II is $(1 - x)y$ and the payoff is -1 . The probability of hitting II is x and the payoff is 1 . The expected payoff of player I is $x + (-1)(1 - x)y$. Suppose they fire at the same time, then $x = y$; the expected payoff is $x + (-1)y = 0$.

By the nature of zero-sum game, we have

$$-u_2(x, y) = u_1(x, y) = \begin{cases} x - (1 - x)y & x < y \\ 0 & x = y \\ -y + (1 - y)x & x > y \end{cases} .$$

We consider mixed strategies for both players:

$$\begin{aligned} P[X \in (x, x + dx)] &= f(x)dx, \quad 0 \leq x \leq 1; \\ P[Y \in (y, y + dy)] &= g(y)dy, \quad 0 \leq y \leq 1. \end{aligned}$$

Our goal is to determine $f(x)$ and $g(x)$, which characterize the mixed strategy of player I and player II, respectively.

Assuming independence of firing decisions in a silent duel, the expected payoff of I is obtained by the weighted sum of the expected payoff of all possible strategies, where

$$E[u_1(X, Y)] = \int_0^1 \int_0^1 u_1(x, y) f(x) g(y) \, dx dy.$$

The value of the game is

$$v = \max_X \min_Y E[u_1(X, Y)] = \min_Y \max_X E[u_1(X, Y)].$$

Recall that this is a zero-sum game. A saddle point (X^*, Y^*) in mixed strategies satisfies

$$E(X, Y^*) \leq E(X^*, Y^*) = v \leq E(X^*, Y).$$

for all distributions of X and Y . We expect $v = 0$ for symmetric game since the two players share the same accuracy function.

By the Equality of Payoff Theorem, if (X^*, Y^*) is a saddle point pair, then they satisfy the following pair of equations:

$$E(X^*, y) = \int_0^1 u_1(x, y) f(x) dx = v = 0, \quad (\text{i})$$

for strategy y that is being used with positive probability. Similarly, we have

$$E(x, Y^*) = \int_0^1 u_1(x, y) g(y) dy = v = 0. \quad (\text{ii})$$

Later, as part of the solution of the mixed strategy $f(x)$, we find the range of values of y such that eqn(i) holds; that is, the strategy that corresponds to the given value of y is used with positive chance. Indeed, y has to be at or above some threshold (equivalently, the distance apart should be close enough).

Consider eq.(i), $u_1(x, y)$ takes different forms when $x < y$ and $x > y$. We may neglect the case $x = y$ since the corresponding probability of occurrence is “almost” zero. We then have

$$E(X^*, y) = \int_0^y [x - (1 - x)y]f(x) dx + \int_y^1 [-y + (1 - y)x]f(x) dx = 0.$$

This is an integral equation for $f(x)$. Our goal is to determine $f(x)$, the density function of the mixed strategy of player I, via the solution of this integral equation.

Solution of the mixed Nash strategy of player I

We identify terms that are independent of y and dependent of y , and obtain

$$\begin{aligned} 0 &= \int_0^y [x - (1-x)y]f(x) \, dx + \int_y^1 [-y + (1-y)x]f(x) \, dx \\ &= \int_0^y xf(x) \, dx - y \int_0^y (1-x)f(x) \, dx \\ &\quad - y \int_y^1 f(x) \, dx + (1-y) \int_y^1 xf(x) \, dx \\ &= \int_0^1 xf(x) \, dx - y \int_0^1 f(x) \, dx + y \int_0^y xf(x) \, dx - y \int_y^1 xf(x) \, dx \\ &= \int_0^1 xf(x) \, dx - y + y \int_0^y xf(x) \, dx - y \int_y^1 xf(x) \, dx. \end{aligned}$$

The first term is $E[X] = \int_0^1 xf(x) \, dx$, which is the mean of the strategy X . It is independent of y .

We define $\psi(x) = xf(x)$ and observe

$$E[X] - y + y \int_0^y \psi(x) \, dx - y \int_y^1 \psi(x) \, dx = 0. \quad (\text{iii})$$

Consider the left side as a function of $y \in [0, 1]$. We define

$$F(y) = E[X] - y + y \int_0^y \psi(x) \, dx - y \int_y^1 \psi(x) \, dx.$$

Since the unknown function $\psi(x)$ is hidden in the integrals, we perform successive differentiation of $F(y)$ with respect to y to obtain an ordinary differential equation for $\psi(x)$:

$$F'(y) = -1 + \int_0^y \psi(x) \, dx + y[\psi(y)] - \int_y^1 \psi(x) \, dx + y[\psi(y)] = 0$$

$$\begin{aligned} F''(y) &= \psi(y) + \psi(y) + y\psi'(y) + \psi(y) + \psi(y) + y\psi'(y) \\ &= 4\psi(y) + 2y\psi'(y) = 0. \end{aligned}$$

This is a first-order ordinary differential equation that is of separable type. Note that

$$\frac{d\psi}{\psi} = -\frac{2}{y} dy$$

so that

$$\ln \psi = -2 \ln y + D.$$

Later, we show that both y and ψ are strictly positive. We then obtain

$$\psi(y) = C \frac{1}{y^2}.$$

Now, $\psi(y) = yf(y) = \frac{C}{y^2}$ implies that $f(y) = \frac{C}{y^3}$, or $f(x) = \frac{C}{x^3}$ in term of the x variable.

We have to determine the constant C using $\int_0^1 f(x) dx = 1$. Unfortunately, $\int_0^1 \frac{1}{x^3} dx$ diverges since $\frac{1}{x^3}$ is not integrable on $[0, 1]$.

What is the nature of the problem? We should expect that the two players do not shoot on the interval $[0, a)$ for some $a > 0$ when the probability function assumes too low value. The appropriate equation for $\psi(x)$ reduces to

$$E[X] - y + y \int_a^y \psi(x) \, dx - y \int_y^1 \psi(x) \, dx = 0,$$

which is the same as where we were before except that 0 is replaced by a . We obtain the same function $\psi(y)$ and eventually the same $f(x) = \frac{C}{x^3}$, except we are now on the interval $a \leq x \leq 1$, where $a > 0$.

Now we have two constants to determine, C and a . Here, C is easy to find since we must have

$$\int_a^1 \frac{C}{x^3} \, dx = 1.$$

This gives

$$C = \frac{2a^2}{1 - a^2} > 0.$$

To find $a > 0$, we substitute

$$f(x) = \frac{C}{x^3}$$

into eq.(iii) to obtain [recall that $\psi(x) = xf(x)$]

$$\begin{aligned} 0 &= E[X] - y + y \int_a^y \psi(x) \, dx - y \int_y^1 \psi(x) \, dx \\ &= y \left(C + \frac{C}{a} - 1 \right) + C \left(-3 + \frac{1}{a} \right). \end{aligned}$$

This must hold for all $a \leq y \leq 1$, which implies that $C + \frac{C}{a} - 1 = 0$.

Therefore, $C = \frac{a}{(a+1)}$. Together with $C = \frac{2a^2}{1-a^2}$, we have

$$C = \frac{2a^2}{1-a^2} = \frac{a}{a+1} \quad \text{giving} \quad a = \frac{1}{3}, \quad C = \frac{1}{4}.$$

Note that X^* is the mixed Nash strategy for player I with density

$$f(x) = \begin{cases} 0, & \text{if } 0 \leq x < \frac{1}{3}; \\ \frac{1}{4x^3}, & \text{if } \frac{1}{3} \leq x \leq 1. \end{cases}$$

From eq.(i), we know

$$E(X^*, y) = \int_a^1 u_1(x, y) f(x) dx = 0 \text{ for } y \geq a.$$

It remains to check that with $C = \frac{1}{4}$ and $a = \frac{1}{3}$, one observes

$$\int_a^1 u_1(x, y) f(x) dx > 0 = v, \text{ when } y < a. \quad (\text{A})$$

That is, we need to check that X played against any pure strategy in $[0, a)$ must give positive value of $E(X, y)$ if X is optimal. This explains why the strategy $y < a$ is never played.

Let us consider the derivative of the function

$$G(y) = \int_a^1 u_1(x, y) f(x) \, dx, \quad 0 \leq y < a.$$

Since $y < x$, we have

$$u_1(x, y) = -y + (1 - y)x,$$

so

$$G(y) = \int_a^1 u_1(x, y) f(x) \, dx = \int_a^1 [-y + (1 - y)x] f(x) \, dx,$$

and obtain

$$G'(y) = \int_a^1 [-1 - xf(x)] \, dx = -\frac{3}{2} < 0.$$

This means $G(y)$ is decreasing on $[0, a]$. Since

$$G(a) = \int_a^1 [-a + (1 - a)x] f(x) \, dx = 0,$$

it must be true that $G(y) > 0$ on $[0, a)$, so condition (A) checks out.

Finally, since this is a symmetric game, it will be true that Y will have the same density as player I.